

SELEZIONE CONTRACT

INDOOR
OUTDOOR
OFFICE
COMUNITÀ
STANDING

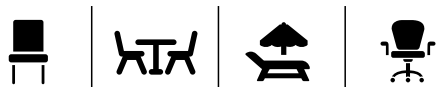

AGGIORNAMENTO TECNICO
NOVEMBRE 2024

NB: i prodotti identificati
NORMALMENTE IN
sono quelli con consegna veloce

con questa scritta
PRONTA CONSEGNA

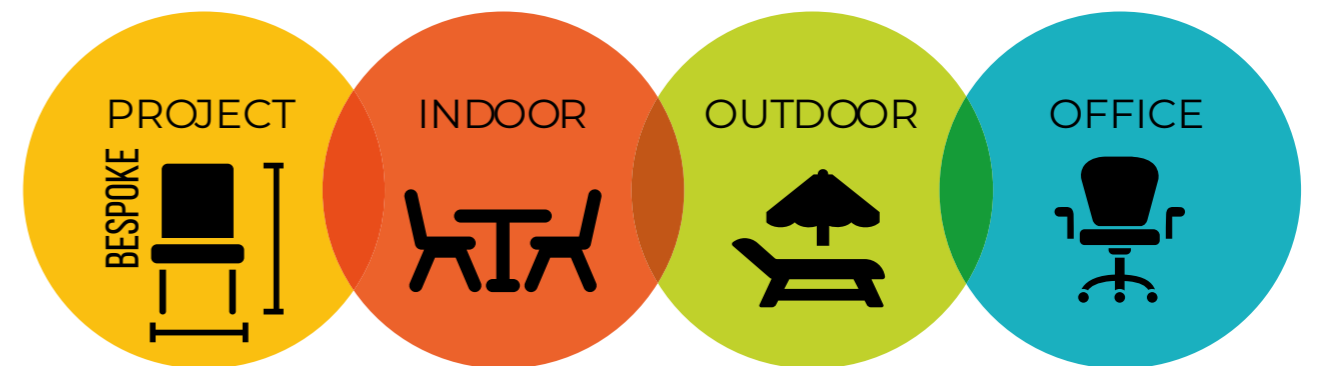



Art. 1032 **Piatta** COD. 00129
40x40-H72 verniciata nera
per piani max 90x90

Art. 1027 **Piatta Big** COD. 00139
50x50-H72 verniciata nera
per piani max 100x100 **disponibile da marzo 2025**



Art. 1032 **Piatta White** COD. 00129
40x40-H72 verniciata bianca
per piani max 90x90



Art. 1031 **Piramide** COD. 00129
40x40-H72 verniciata nera
per piani max 90x90



Art. 1037/D **Kuadra Double**

(2 colonne 8x8) 75x40-H72 per piani max 140x90

verniciata nera	COD. 00260
inox lux	COD. 00270
inox satinato	COD. 00290

NORMALMENTE IN PRONTA CONSEGNA
PREZZI SPECIALI PER BANCALE 50 PZ., CONTATTARE UFFICIO COMMERCIALE



Art. 1034 **Piatta Snack** COD. 00159

40x40-H108
verniciata: **nera - bianca**
per piani max 70x70

**TAGLIO A MISURA
IN ALTEZZA**
+ € 45,00 netti



PIANI CLIENTI
schema di foratura G02 (piastra 300 x 300 mm)
per basi:
1031 - 1032 - 1034 - 1037 - 1046 LS **Como**

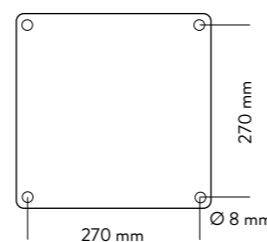

Piedino regolabile



■ **Piatta Gold**

Art. 1024 40x40-H72 tubo 8x8 - per piani max 90x90
ottone galvanico satinato COD. 00168

Art. 1025 40x40-H108 tubo 8x8 - per piani max 70x70
ottone galvanico satinato COD. 00177
disponibile da marzo 2025



■ Art. 1026 **Como Gold**

Ø45-H72 tubo Ø8 - per piani max Ø80 - 70x70

ottone galvanico satinato COD. 00179

BASI TONDE



Base **Como** verniciata nera
 Ø45-H73 Art. 1046.**LS45** COD. 00139
 per piani max Ø80 - 70x70

Ø54-H73 Art. 1046.**LS54** COD. 00168
 per piani max Ø100 - 80x80

Ø60-H73 Art. 1046.**LS60** COD. 00196
 per piani max Ø130

Piedino regolabile

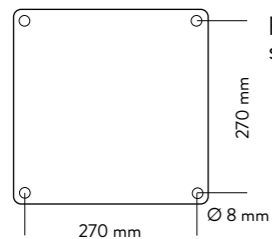

piani clienti,
 schema di foratura G02

ACCESSORIO
anello ottone H 10 cm
 per **Base Como:**
 satinato + € 18,00
 lucido + € 24,00

per **Base Quadra:**
 satinato + € 23,00
 lucido + € 29,00

**NORMALMENTE
 IN PRONTA
 CONSEGNA**



Base Art. 1046 **LSH**
Como Snack COD. 00158

H108 Ø45 con piedini **nera**
 adatta anche per **OUTDOOR**
 per piani max 70x70



Art. 641/5 **Max**
 COD. 00430
 base Ø 70 - max piano Ø 130
 colori: **bianco - antracite**



Art. 643 **Island**
 ■ **BASE ACCIAIO VERNICIATA bianca - solo base**
 Ø 65 - H 71 COD. 00690
 ■ **BASE ACCIAIO VERNICIATA nera opaca - solo base**
 Ø 65 - H 71 COD. 00760
 supplemento per sottopiano H3 cm nobilitato bianco COD. 0090
 per sopperire altezza tavolo



Art. 611 **Shai**
 ■ **BASE ACCIAIO VERNICIATA: nera - bianca**
solo base Ø 69 - H 72,5 COD. 00590

NORMALMENTE IN PRONTA CONSEGNA



104x54 - H 74 Art. 682
 piano cliente legno
 COD. 001270

Base **Urania**
 ■ **ACCIAIO VERNICIATA nera**

Ø 60 - H 74 Art. 681
 piano cliente legno
 COD. 00790



Art. 1035 **Big Round**
 verniciata nera
 COD. 00290

per piani max Ø180

**NORMALMENTE IN
 PRONTA CONSEGNA**

Piedino regolabile

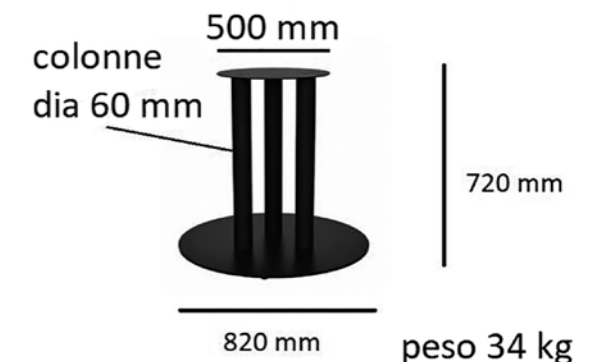
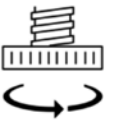



Art. 1037/D **Kuadra Double**
(2 colonne 8x8) 75x40-H72 per piani max 140x90

acciaio **inox lucido** COD. 00270
acciaio **satinato** COD. 00290
verniciata **nera** COD. 00260



Art. 1037 **Kuadra Lux**
versione acciaio **inox lucido**
40x40-H72 - tubo 8x8
per piani max 90x90

COD. 00148



Art. 1037 **Kuadra Satinè**
COD. 00148
versione acciaio **satinato**
40x40-H72 - tubo 8x8
per piani max 90x90

Base Art. 1053 **Spritz**

NORMALMENTE IN PRONTA CONSEGNA

metallo verniciato **nero**

per piani max 60x60 - Ø60
uso **bar/gelateria**

NO ristorazione

COD. 00108



BASI ACCIAIO lucido o satinato

NORMALMENTE IN PRONTA CONSEGNA

Piedino regolabile



Modello TORINO

acciaio **satinato**

H73 Art. 1036/1 COD. 00138
H108 Art. 1036/2 COD. 00157

Base Ø45 - Tubo 76 mm
per piani max Ø80 - 70x70

piani clienti, schema di foratura G02

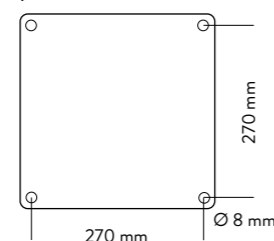

Art. 1037 HG **Kuadra High**
COD. 00159
acciaio **satinato**
40x40-H108 - tubo 8x8
per piani max 80x80



Mod. Troll fissa

alluminio verniciato **nero**
con zavorra interna

H73 Art. 1740/1 per piani max 80x80

COD. 00127

H108 Art. 1740/2 per piani max 70x70

COD. 00139

piani clienti, schema di foratura G02

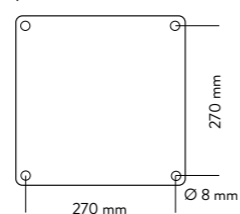

Piedino regolabile



NORMALMENTE IN PRONTA CONSEGNA



BASI CLASSICHE



Piedino regolabile



Art. 1043 Bistrot

43x43-H73 COD. 00163

- verniciata nera
- per piani max 90x90

- foratura non adatta per piani Art. 1049
(usare n. 8 viti autofilettanti)

Art. 1041 Bistrot Snack

43x43-H108 COD. 00187

- verniciata nera
- per piani max 80x80

- foratura non adatta per piani Art. 1049
(usare n. 8 viti autofilettanti)



Art. 1052 Impero

43x43-H73 COD. 00163

- verniciata nera
- per piani max 90x90

- foratura non adatta per piani Art. 1049
(usare n. 8 viti autofilettanti)

Piedino regolabile



NORMALMENTE IN PRONTA CONSEGNA

NORMALMENTE IN PRONTA CONSEGNA



PIANI IN ESSENZA



Piano Art. 1059 **Rovere Contemporaneo**
 SPESSORE 4 CM, IMPIALLACCIATO ROVERE, FINITO A OLIO.
BORDO EFFETTO CORTECCIA DUE LATI
 oppure DRITTO QUATTRO LATI

70x70 COD. 00380
 80x80 COD. 00390
 90x90 COD. 00390 solo bordo dritto

MISURE FISSE
 ordine min. 10 pz.
 con acconto - tempi 40/50 gg



BORDO DRITTO

70x70 COD. 00380
 80x80 COD. 00420
 90x90 COD. 00495
 Ø 120 COD. 00990
 Ø 140 COD. 001290

Piano **Rovere Nature**

Spessore 4 cm, legno listellare, placcato con lastrone in rovere 7 nodi, caratteristico per la sua nodosità e le stuccature in contrasto. Bordatura in corteccia naturale e controvena. Finito con vernice atossica, zero gloss, per mantenere l'effetto naturale della superficie.



TOP e BORDI LISTELLARE 7 NODI



ROVERE NATURALE ROVERE T. NOCE ROVERE T. NERO ROVERE MULTICOLOR

ANCHE SU MISURA

TOP ABETE DOGATO



T. NOCE CHIARO T. NOCE SCURO T. NERO LEVIGATO MULTICOLOR

DOGHE IN MASSELLO DI ABETE TRATTATO IN AUTOCLAVE ADATTI ANCHE PER OUTDOOR

Art. 712 **Parsifal**

- **NORMALMENTE IN PRONTA CONSEGNA**
- GAMBE METALLO VERNICIATE NERE
- PIANO impiallacciato rovere naturale/effetto corteccia FINITO OLIO - SPESSORE 4 CM
- MISURE H 77:
 - 160 x 90 COD. 001070 spazio tra gamba e gamba 117
 - 180 x 90 COD. 001090 spazio tra gamba e gamba 120
- SOLO GAMBE PER PIANO CLIENTE COD. 00580 NB: essendo a due blocchi, senza il piano non è autoportante



Art. 1050/16 **Petalo**

multistrati bordo a vista tinto, placcato laminato HPL - colori vedi Art. 1058

ordine min. 5 pz.
 tempi circa 40 gg.

Chiuso □ 80x80 / aperto Ø115 COD. 00660
 90x90 / aperto Ø125 COD. 00690

Aperto ○ Ø 115 (x 4/5 sedute)
 Ø 125 (x 5/6 sedute)



Piano **Abete Industrial**

spessore 4 cm, legno in abete trattato in autoclave, finito con vernice atossica all'acqua, zero gloss, per mantenere l'effetto naturale della superficie. Cornice in metallo ferro nero verniciata trasparente naturale.

BORDO METALLO

70x70 COD. 00390
 80x80 COD. 00470
 90x90 COD. 00560
 misure tonde non realizzabili

BORDO ASSI A VISTA

70x70 COD. 00295
 80x80 COD. 00350
 90x90 COD. 00395
 Ø 120 COD. 00680
 Ø 140 COD. 00790

Piani Art. 1049 nobilitato **espressi** USO INDOOR

NORMALMENTE IN PRONTA CONSEGNA

misure e colori tassativamente fissi (no costo gestione) CONSEGNA SU BANCALE REGGIATO

colori non compatibili con Art. 1060/1061 i su misura

foratura bussole solo per basi: Art. 1031 - 1032 - 1034 - 1037 - 1038 - 1046.LS45/54/60

Per altre basi: applicazione bussole antistrappo (con vite brugola) + € 8,00 netti



1
2
3
4
5



1 VINTAGE (CLEAF)

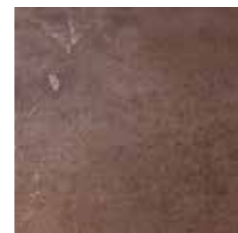

2 CORTEN (CLEAF)



3 GRAFITE (CLEAF)



4 CEMENTO (CLEAF)



5 BIANCO P.A. (CLEAF)



ROVERE NATURALE CONTEMPORANEO

NOBILITATO / BORDO ABS:  spessore 25 mm

dimensione **67x67** COD. 0098

dimensione **80x80** COD. 00127

I nostri piani hanno incluse bussole antistrappo con viti 6MA



Art. 1050 **GPR GANCI PER PROLUNGA per basamento centrale**

COD. 0016 cad. Gancio per prolungha, con gancio si intende maschio / femmina (set 4 ganci per singola prolungha COD. 0064)

solo per piani 25 mm Art. 1049 da aggiungere costo (non applicabili su piani 50 mm, e stratificati)

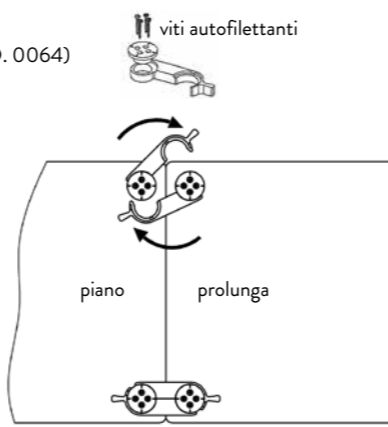
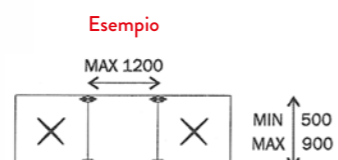

montaggio sui top non compreso

Piani contract nobilitato **"i su misura"** Art. 1060-1061 per interni - colori non compatibili con Art. 1049 espressi

■ **TEMPI 20/30 GG** - CONSEGNA SU BANCALE REGGIATO

■ COSTI GESTIONE TECNICA, ORDINI SOTTO:

5 PIANI + € 40,00 NETTI - 10 PIANI + € 30,00 NETTI - 15 PIANI + € 20,00 NETTI - OLTRE 20 PIANI NESSUN SUPPLEMENTO

NB: PER QUESTO TIPO DI PIANI VERRÀ CHIESTO UN ACCONTO PER LA MESSA IN PRODUZIONE



CORTEN (44408)



ROVERE NATURALE (V32)



OLMO TINTO (WG9)



OLMO GRIGIO (WG8)



BIANCO P.A. (B01)



CEMENTO (44375)



ANTRACITE (KINDL)
SOLO 25 mm

I nostri piani hanno incluse bussole antistrappo con viti 6MA



 **25 mm - Art. 1060**

nobilitato bordo ABS: **bianco liscio**

■ 60 x 60 COD. 0066
■ 70 x 70 COD. 0074
■ 80 x 80 COD. 0096
■ 90 x 90 COD. 00116

■ 120 x 80 COD. 00143
■ 140 x 80 COD. 00164
■ 160 x 80 COD. 00186

■ Ø 60 COD. 0088
■ Ø 70 COD. 0097
■ Ø 80 COD. 00126
■ Ø 90 COD. 00146
■ Ø 100 COD. 00189
■ Ø 110 COD. 00228
■ Ø 120 COD. 00267

nobilitato special bordo ABS in tinta: **colori speciali** vedi sopra

COD. 0084
COD. 00104
COD. 00139
COD. 00159

COD. 00188
COD. 00212
COD. 00264

COD. 00108
COD. 00129
COD. 00169
COD. 00189
COD. 00228
COD. 00276
COD. 00327



 **50 mm - Art. 1061**

nobilitato bordo ABS in tinta: **bianco liscio**

COD. 00100
COD. 00116
COD. 00142
COD. 00176

COD. 00198
COD. 00232
COD. 00282

COD. 00126
COD. 00144
COD. 00168
COD. 00212
-
-

nobilitato special bordo ABS in tinta: **colori speciali** vedi sopra

COD. 00112
COD. 00132
COD. 00182
COD. 00207

COD. 00209
COD. 00244
COD. 00308

COD. 00136
COD. 00162
COD. 00208
COD. 00234
-
-

A RICHIESTA ANCHE SU MISURA

Per questo tipo di prodotto verrà richiesto tassativamente acconto

Piani Art. 1051 HPL stratificato **espressi** INDOOR / OUTDOOR

 spessore 10 mm, bordo dritto, **con attacco universale**

Sistema di fissaggio universale

Possibilità di applicazione a tutte le basi

VITERIA
SPECIALE
INCLUSA

misure e colori tassativamente fissi

(no costo gestione) CONSEGNA SU BANCALE REGGIATO

DALLE MISURE INDICATE MANCA 1 CM PER LATO

colori non compatibili con
Art. 1058 i su misura

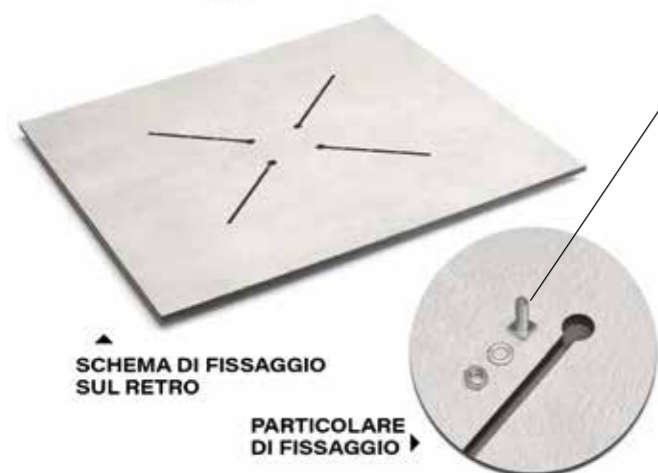

NORMALMENTE IN PRONTA CONSEGNA NO COSTO GESTIONE

NEWS pietra gold



rovere nodato MAH
70x70 COD. 00184* - 00168** - 00149***
80x80 COD. 00209* - 00189** - 00173***



corten CRT
70x70 COD. 00184* - 00168** - 00149***
80x80 COD. 00209* - 00189** - 00173***



marmo nero THT
70x70 COD. 00184* - 00168** - 00149***
80x80 COD. 00209* - 00189** - 00173***

IMPORTANTE: I COLORI SCURI VANNO TENUTI IN ZONE OMBREGGiate
(L'ASSORBIMENTO DEI RAGGI UVA ACCUMULA CALORE E TENDONO A STORTARSI)



cemento CMT
70x70 COD. 00184* - 00168** - 00149***
80x80 COD. 00209* - 00189** - 00173***



marmo bianco BLI
70x70 COD. 00199* - 00177** - 00158***
80x80 COD. 00228* - 00196** - 00179***



bianco BNC (corpo nero)
70x70 COD. 00168* - 00149** - 00139***
80x80 COD. 00196* - 00176** - 00163***

* ORDINI DA 1 A 9 PZ.

** ORDINI DA 10 A 19 PZ.

*** ORDINI OLTRE 20 PZ.
ordini per magazzino oltre
40 PZ. EXTRA SCONTO 5%



NEWS

pietra gold GLD

70x70 COD. 00199* - 00177** - 00158***
80x80 COD. 00228* - 00196** - 00179***

Piani Art. 1058 **HPL stratificato** “i su misura” per interni / esterni

 spessore 10 mm, bordo dritto, **con attacco universale**

colori non compatibili con Art. 1051 espressi

▪ **TEMPI 25/40 GG** - CONSEGNA SU BANCALE REGGIATO

▪ **COSTI GESTIONE TECNICA, ORDINI SOTTO:**
5 PIANI + € 40,00 NETTI - 10 PIANI + € 30,00 NETTI - OLTRE 10 PIANI NESSUN SUPPLEMENTO

NB: PER QUESTO TIPO DI PIANI VERRÀ CHIESTO UN ACCONTO PER LA MESSA IN PRODUZIONE



BIANCO *
(001 FIN. R. corpo nero)



MARMO BIANCO LISCIO **
(5547 FIN. OPACA corpo nero)



PIETRA CHIARA **
(6075 FIN. PLAMKY corpo nero)



PIETRA SCURA **
(6076 FIN. PLAMKY corpo nero)



ARDESIA FIN. PIETRA **
(3349 FIN. LUNA corpo nero)



CEMENTO FIN. PIETRA **
(3192 FIN. LUNA corpo nero)



CORTEN **
(3276 FIN. LUNA corpo marrone)



ROVERE NATURALE ***
(4543 FIN. ALEVE corpo marrone)



ROVERE SLAVONIA ***
(4587 FIN. ALEVE corpo marrone)



MARMO SCURO LUCIDO ***
(6086 LUCIDO corpo nero)

IMPORTANTE: I COLORI SCURI VANNO TENUTI IN ZONE OMBREGGiate
(L'ASSORBIMENTO DEI RAGGI UVA ACCUMULA CALORE E TENDONO A STORTARSI)

DIMENSIONI:

60x60 - Ø 60	* COD. 00112	** COD. 00120	*** COD. 00142
70x70 - Ø 70	* COD. 00168	** COD. 00178	*** COD. 00188
80x80 - Ø 80	* COD. 00196	** COD. 00204	*** COD. 00232
90x90 - Ø 90	* COD. 00239	** COD. 00276	*** COD. 00288
Ø 100	* COD. 00312	** COD. 00348	*** COD. 00376
Ø 120	* COD. 00464	** COD. 00519	*** COD. 00598
Ø 130	* COD. 00528	** COD. 00552	*** COD. 00629
120x80	* COD. 00312	** COD. 00342	*** COD. 00379
140x80	* COD. 00328	** COD. 00384	*** COD. 00386
160x80	* COD. 00392	** COD. 00432	*** COD. 00434

A RICHIESTA ANCHE SU MISURA

DALLE MISURE INDICATE
MANCA 1 CM PER LATO
RAGGIO ANGOLI 10 MM.

I nostri piani hanno incluse
bussole antistrappo
con viti 6MA



A RICHIESTA FRESATURA PER VITI ATTACCO UNIVERSALE
+ € 18,00 A PIANO (INCLUSO VITI SPECIALI)
OBBLIGATORIO PER BASE CLIENTE e Art. 1052 Impero

i LUXURY TOP

lucidi, resistenti, **non assorbono.....** e glamour



Top 1050/29 Vitrum

PIANO VETRO RETROLACCATO

accoppiato con nobilitato, spessore totale 30 mm, bordo ABS antiurto

BORDO: **ottone lucido o satinato** (altri colori a richiesta)

SOTTO 10 PZ. GESTIONE TECNICA € 45,00 netti - TEMPI 40 GG

misure particolari a richiesta

**NB: PER LA MESSA IN PRODUZIONE
NECESSITA ACCONTO**



include bussole antistrappo
con viti 6MA

■ QUADRATO:	bianco-nero	RAL (ordine min. 10 pz. TAX)
60 x 60	COD. 00240	COD. 00290
70 x 70	COD. 00260	COD. 00330
80 x 80	COD. 00290	COD. 00395
90 x 90	COD. 00330	COD. 00440
■ TONDO o QUADRO CON ANGOLI RAGGIO 50 mm		
Ø 60 - 60 x 60	COD. 00260	COD. 00320
Ø 70 - 70 x 70	COD. 00280	COD. 00390
Ø 80 - 80 x 80	COD. 00310	COD. 00470
Ø 90 - 90 x 90	COD. 00360	COD. 00490
Ø 100	COD. 00670	-
Ø 110	COD. 00770	-
Ø 120	COD. 00890	-

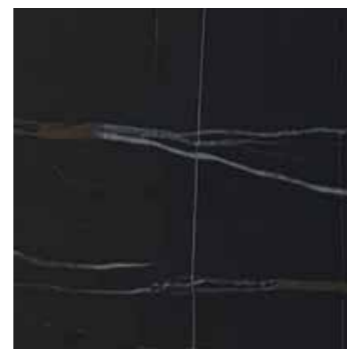

SAHARA NOIR



VERDE AVER



ONICE PERLA



MARMO GOLD



BIANCO APUANE

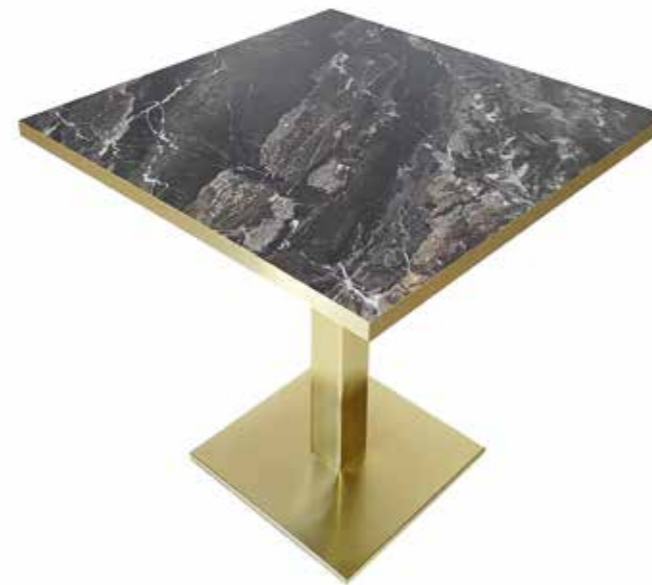

MARMO SCURO LUCIDO - PRINT 1456 FIN. LUCIDO



MARMO CHIARO LUCIDO - PRINT 1459 FIN. LUCIDO

Top 1102 Marmo Lux

- PIANO LAMINATO HPL LUCIDO
CONTROPLACCATO

BORDO: **ottone lucido o satinato** (altri colori a richiesta)

- Base **Piatta Ottone galvanico**

40x40-H72 tubo 8x8 - per piani max 90x90

satinato come foto COD. 00168

ORDINE MINIMO 10 PZ TAX - TEMPI 30/40 GG.

Top 1050/30 Ceramico lucido

- PIANO CERAMICA LUCIDA
accoppiato con nobilitato, spessore totale 30 mm, bordo ABS antiurto

BORDO: **ottone lucido o satinato** (altri colori a richiesta)

	SAHARA NOIR VERDE AVER ONICE PERLA	MARMO GOLD BIANCO APUANE
■ QUADRATO		
60 x 60	COD. 00290	COD. 00257
70 x 70	COD. 00460	COD. 00380
80 x 80	COD. 00489	COD. 00428
■ TONDO		
Ø 60	COD. 00332	COD. 00304
Ø 70	COD. 00488	COD. 00408
Ø 80	COD. 00536	COD. 00460

SOTTO 10 PZ. GESTIONE TECNICA € 45,00 netti - TEMPI 40 GG

include bussole antistrappo
con viti 6MA

NB: PER LA MESSA IN PRODUZIONE NECESSITA ACCONTO

spessore 30 mm

- QUADRATO

60 x 60	COD. 0092
70 x 70	COD. 00124
80 x 80	COD. 00144
90 x 90	COD. 00172
120 x 80	COD. 00196
- TONDO o QUADRO CON ANGOLI RAGGIO 50 mm

Ø 60	COD. 00124
Ø 70	COD. 00153
Ø 80	COD. 00184
Ø 90	COD. 00236

DALLE MISURE INDICATE MANCA 1 CM PER LATO

- COSTI GESTIONE TECNICA,
ORDINI SOTTO:
5 PIANI + € 30,00 NETTI
10 PIANI + € 20,00 NETTI
OLTRE 10 PIANI NESSUN SUPPLEMENTO

NB: PER LA MESSA IN PRODUZIONE
NECESSITA ACCONTO

spessore 50 mm

- QUADRATO

60 x 60	COD. 00126
70 x 70	COD. 00158
80 x 80	COD. 00176
90 x 90	COD. 00214
120 x 80	COD. 00248
- TONDO

Ø 60	COD. 00148
Ø 70	COD. 00186
Ø 80	COD. 00216
Ø 90	COD. 00256

- TEMPI 25/30 GG
CONSEGNA SU BANCALE REGGIATO

include bussole antistrappo
con viti 6MA

I NOMI DELLE SEGUENTI CERAMICHE SONO DA CONSIDERARSI PURAMENTE CASUALI E NON SI RIFERISCONO AI MARMI NATURALI.
PER MOTIVI DI LAVORAZIONE, LA MISURA FINITA DEI PIANI SARÀ DI QUALCHE MILLIMETRO IN MENO, RISPETTO ALLE DIMENSIONI SOPRA INDICATE.
LE VENATURE DELLA CERAMICA POSSONO RISULTARE DIFFERENTI DA PIANO A PIANO.



il tavolo al centimetro...

Art. 663 Kerwin

- **NORMALMENTE IN PRONTA CONSEGNA**, solo struttura misure di serie - *taglio struttura misura + 70,00 netti (LE STRUTTURE SONO PIÙ CORTE DI 1 CM PER LATO, TEMPI 30 GG)

adatto per piani in marmo, agglomerati, ecc. (non adatto per piani vetro trasparente)

MISURE: SEZIONE GAMBA 4 X 4	80 x 80 90 x 90	120 x 70	120 x 80	140 x 80	160 x 90	180 x 90
■ COMPLETO DI PIANO NOBILITATO 20 mm bianco - H 75	COD. 00445	COD. 00480	COD. 00495	COD. 00520	COD. 00560	COD. 00590
■ *solo struttura PIANO CLIENTE - H 73						
■ VERNICIATA alluminio	COD. 00320	COD. 00330	COD. 00340	COD. 00360	COD. 00380	COD. 00395
■ VERNICIATA bianca	COD. 00320	COD. 00330	COD. 00340	COD. 00360	COD. 00380	COD. 00395
■ VERNICIATA antracite	COD. 00320	COD. 00330	COD. 00340	COD. 00360	COD. 00380	COD. 00395



NUOVA VERSIONE H110 + COD. 0090

solo verniciata: bianca e antracite



particolare giunto brevettato

TESSUTI A MAGAZZINO SOLO PER MODELLI CUSTOM



VELLUTO ANTIMACCHIA non ignifugo CAT B

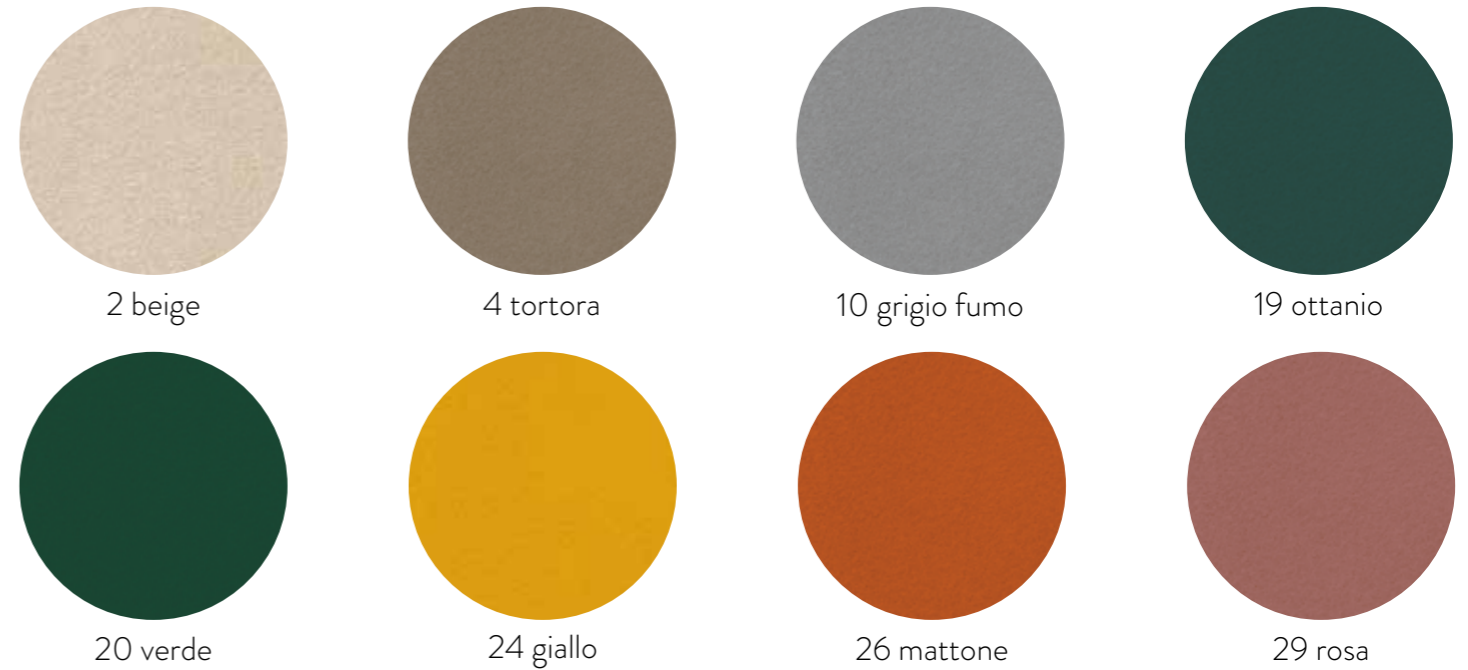

IL VELLUTO POTREBBE PRESENTARE EFFETTI CHE NON SONO DA CONSIDERARE DIFETTOSITÀ IN QUANTO CARATTERISTICHE DELLA COMPOSIZIONE E DEL TIPO DI LAVORAZIONE: EFFETTO A MACCHIA O MARZZATURA, EFFETTO CHIARO/SCURO, EFFETTO IMPRONTA

COLORI SU ORDINAZIONE non ignifugo CAT B (ignifugo CAT C)



ECOPELLE ignifuga CAT B (supporto cotone - PVC 69% - Martindale 51.200 Dry) PRODOTTI SENZA FTALATI - MADE IN ITALY

EVO Art. 345/1 effetto soft touch

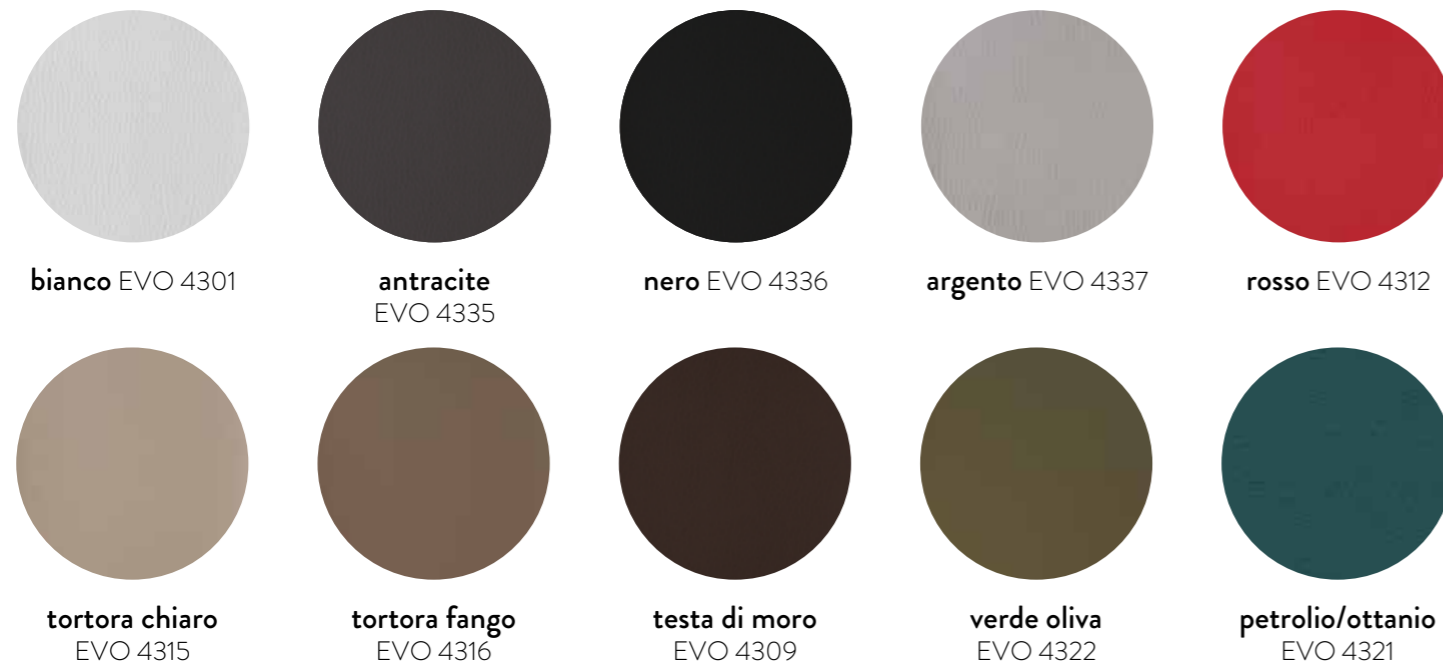

L'ECOPELLE NEI COLORI CHIARI POTREBBE MACCHIARSI A CONTATTO CON INDUMENTI NON TRATTATI (ES. JEANS). PER LA PULIZIA DEI PRODOTTI UTILIZZARE SOLO ACQUA TIEPIDA E UN PANNINO MORBIDO IN MICROFIBRA. NON USARE SOLVENTI O PRODOTTI AGGRESSIVI.

Ecopelle **NABUK** Art. 345/3 CAT. B

(supporto cotone - PVC 69% - Martindale 51.200 Dry)
 PRODOTTI SENZA FTALATI - **MADE IN ITALY**



creme NBK 4342



sabbia NBK 4344



avio EVO 4350



beige NBK 4343



antracite NBK 4353



verde oliva EVO 4351



tortora chiaro NBK 4346



tortora fango NBK 4347



nociola NBK 4345

Ecopelle **SQUALO** Art. 345/5 *effetto pelle animale anticato* CAT. B



grigio chiaro SQ 4371



naturale chiaro SQ 4362



naturale scuro SQ 4363



tortora SQ 4364



marrone SQ 4365



testa di moro SQ 4366

FAST CLEAN idrorepellente/antimacchia CAT B



SCARICA QR

PER LE INCREDIBILI
 PERFORMANCE



FACEBUK
 tipo nabuk



Col. F600



Col. F400



Col. F603



Col. F503



Col. F307



Col. F808



Col. F705



Col. F611

KARIBU
 tipo scamosciato



Col. K600



Col. K411



Col. K402



Col. K403



Col. K800

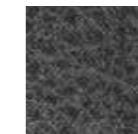

Col. K601



Col. K801



Col. K704

PRATIKO
 tipo ciniglia



Col. P601



Col. P401



Col. P403

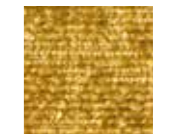

Col. P520



Col. P300



Col. P801



Col. P804



Col. P706



Col. P603



Col. P200

VIKTORIA
 tessuto grana grossa



Col. V101



Col. V401



Col. V603



Col. V501



Col. V307

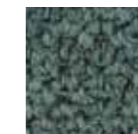

Col. V700



Col. V606



Col. V601

MAXIMA ROUND

TOTALMENTE PRODOTTA INTERNAMENTE
ANCHE SU MISURA

TEMPI 40/50 GG
CON ACCONTO



Art. 724/1 Panka MAXIMA ROUND

H108 - P62 (hs46)

Ø ESTERNO 210 (Ø tavolo 90)	COD. 005990
Ø ESTERNO 230 (Ø tavolo 110)	COD. 006180
Ø ESTERNO 240 (Ø tavolo 120)	COD. 006260
Ø ESTERNO 250 (Ø tavolo 130)	COD. 006490
Ø ESTERNO 260 (Ø tavolo 140)	COD. 006780

Tessuto: **ecopelle - velluto - Fast Clean**
(retro rivestito, finito a vista)

GOMMA IGNIFUGA / ECOPELLE IGNIFUGA +15%
GOMMA IGNIFUGA / VELLUTO IGNIFUGO +20%

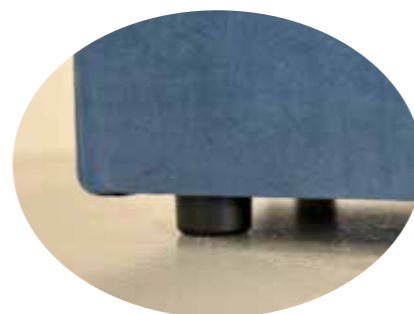

particolare piedini polipropilene



PROGRAMMA PANKA SOFT

TOTALMENTE PRODOTTE INTERNAMENTE
ANCHE SU MISURA

TEMPI 40/50 GG
CON ACCONTO



Art. 722/3 Panka base terra **BOTTONI**

spessore cuscino 20 cm

H101 - P62	L120	L140
con tessuto CAT B	COD. 001530	COD. 001710
tessuto cliente	COD. 001320 (3,5 mt)	COD. 001430 (4,5 mt)

ELEMENTO ANGOLARE 62x62

con tessuto CAT B	COD. 001790	COD. 001990
tessuto cliente	COD. 001560 (3,5 mt)	COD. 001650 (4,2 mt)

composizione angolare, in fase d'ordine inviare la disposizione in pianta

Tessuto: **ecopelle - velluto - Fast Clean** (retro rivestito, finito a vista)

GOMMA IGNIFUGA / ECOPELLE IGNIFUGA +15%
GOMMA IGNIFUGA / VELLUTO IGNIFUGO +20%



Tavolo Art. 721/T **Fratino Restile**

■ BASE Art. 1037/D: **nera - acciaio satinato - inox lucido**
■ PIANO spessore 50 mm COLORI vedi piani Art. 1061

MISURE: 120 x 80
MISURE: 140 x 80

COD. 00640
COD. 00680

Base nobilitato colori:



bianco

antracite

nero

MAXIMA LINE

TOTALMENTE
PRODOTTA INTERNAMENTE
ANCHE SU MISURA

TEMPI 40/50 GG
CON ACCONTO



composizione angolare,
in fase d'ordine inviare la disposizione in pianta



schienale
MODULI ORIZZONTALI
(da grande a piccolo a salire)

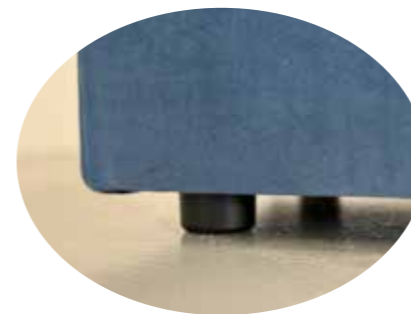

particolare piedini polipropilene
di serie

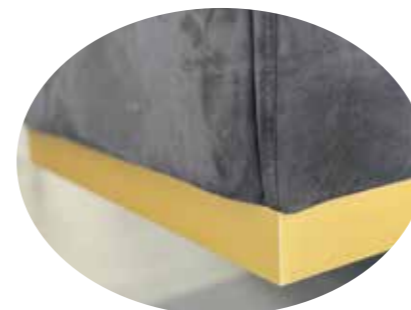

OPTIONAL
base bordo ottone: lucido - satinato
L120 + € 220 - L140 + € 250

H107 - P62 (hs47)

Art. 724/5 **SCHIENALE LISCIO**
L120 COD. 001190
L140 COD. 001280
ANGOLO COD. 001160

Art. 724/6 **SCHIENALE RIGHE**
L120 COD. 001250
L140 COD. 001345
ANGOLO COD. 001220

Art. 724/7 **SCHIENALE MODULI**
L120 COD. 001320
L140 COD. 001420
ANGOLO COD. 001290



Art. 807 **Cilindro**

Tessuto: **ecopelle - velluto - Fast Clean**
(retro rivestito, finito a vista)

GOMMA IGNIFUGA / ECOPELLE IGNIFUGA +15%
GOMMA IGNIFUGA / VELLUTO IGNIFUGO +20%



base foto non disponibile, vedi Art. 1053 Spritz



Brill

Bottoni



a muro oppure
panca contro panca

Art. 722/6 Panka Base piedini

P60 - Tessuto: **ecopelle** - velluto - retro rivestito, finito a vista

H109	L120	L140
Bottoni	COD. 001450	COD. 001600
Brill	COD. 001630	COD. 001820

H138	L120	L140
Bottoni	COD. 001590	COD. 001740
Brill	COD. 001780	COD. 001960

ELEMENTO ANGOLARE 60x60

Bottoni	COD. 001830	COD. 002020
Brill	COD. 002060	COD. 002380

composizione angolare, in fase d'ordine inviare la disposizione in pianta



Art. 720 Panka Young

L120 - P56 - HS48 - HT85 - ORDINE MINIMO 4 PZ. - TEMPI 40 GG

- METALLO VERNICIATO: **bianco - nero**
- STOFFE CATEGORIA B COD. 00590
- STOFFA CLIENTE (2 MT) COD. 00540
- SUPPLEMENTO PER GOMMA IGNIFUGA **40,00**



1085/5 Discoteque POLTRONCINA PER LOCALE PUBBLICO STRUTTURA IN POLIURETANO IGNIFUGO RIVESTITA ECOPELLE

elemento poltrona STE.1 (stoffa cliente 1,7 mt - € 395,00)	COD. 00520
elemento divano 2 posti STE.2 (stoffa cliente 3,4 mt - € 620,00)	COD. 00845
elemento spicchio angolo 45° circolare chiuso STE.AC (stoffa cliente 1,7 mt - € 430,00)	COD. 00545
elemento angolo 90° quadro chiuso STE.AQ (stoffa cliente 3,4 mt - € 650,00)	COD. 00880
elemento angolo 90° aperto senza schienale STE.AA (stoffa cliente 1,5 mt - € 395,00)	COD. 00520
elemento angolo 90° aperto con schienale STE.AASCH (stoffa cliente 1,8 mt - € 440,00)	COD. 00585

Ordine minimo 12 elementi anche misti - tempi 40/50 gg

PRODOTTO IN POLIURETANO IGNIFUGO CERTIFICATO CLASSE 1M

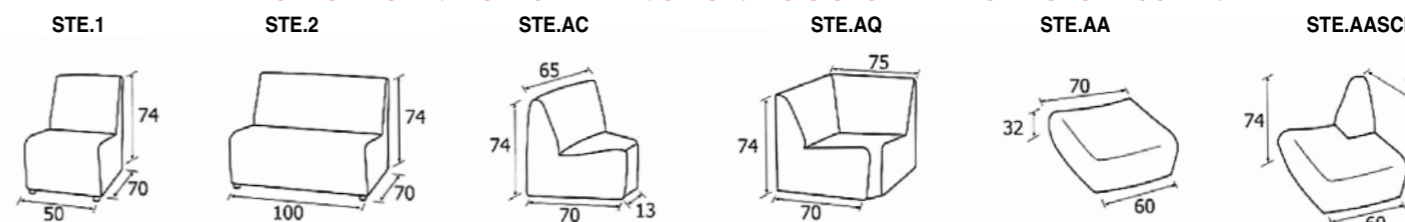



Art. 807 Cilindro

- **IMBALLO N. 1 pz.**
- **TEMPI 15/25 GG.**
- **POUF BASE NOBILITATO / BORDO ABS OTTONE**
PARTE INTERNA POLISTIROLO ALTA DENSITÀ RIVESTITO IN VELLUTO:
beige - tortora - grigio fumo - ottanio
verde - giallo - mattone - rosa antico COD. 00176
- stoffa cliente (1 mt.)** COD. 00161

CUSTOMIZZABILE

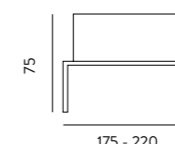
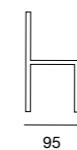
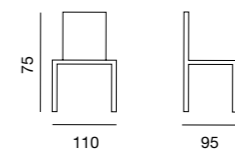
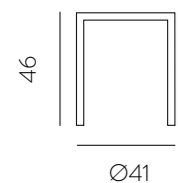

CUSTOMIZZABILE

Art. 430 Regency

- **POLTRONA**
CAT. B COD. 002395
stoffa cliente COD. 001980
STOFFA 7 ML - PELLE 10 MQ
- **DIVANO 2 POSTI**
CAT. B COD. 003140
stoffa cliente COD. 002590
STOFFA 10 ML - PELLE 15 MQ
- **DIVANO 3 POSTI**
CAT. B COD. 003760
stoffa cliente COD. 003090
STOFFA 12 ML - PELLE 17 MQ



- **TEMPI 40/50 GG. (da ricevimento acconto)**



**ecopelle
nera**

stoffa cliente

**finta pelle
colorata**
(vedi mod. Techne)

**OMOLOGATO iM
finta pelle ignifuga**
(vedi mod. Techne)

Art. 409/1 Poltrona 1P	COD. 00680	COD. 00640 mt. 3,00
Art. 409/2 Divano 2P	COD. 00970	COD. 00910 mt. 5,50
Art. 409/3 Divano 3P	COD. 001190	COD. 001130 mt. 6,90

COD. 00750	COD. 00830
COD. 001060	COD. 001160
COD. 001290	-

struttura in legno, faesite truciolare - piedini in metallo cromato

TEMPI 30 GG

**mod. Brema
CUSTOMIZZABILE**

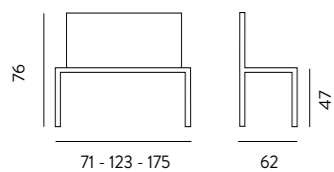

mod. Halifax

struttura metallo tubolare 3x3 **acciaio lucido**

ecopelle: NERA - BIANCA NEWS

Art. **434/1** Poltrona 1P COD. 00790

Art. **434/2** Divano 2P COD. 001180

NORMALMENTE IN PRONTA CONSEGNA

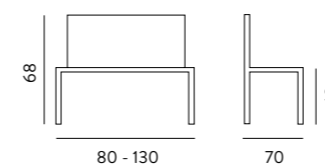



modello Larking

struttura nera / **tessuto grigio**

▪ **NORMALMENTE IN PRONTA CONSEGNA**

divanetto Art. 398/2 125x72xH78 - HS40

poltrona Art. 398/1 67x72xH77 - HS40

pouf Art. 398/3 42x42xH47

CUSTOMIZZABILE

COD. 00786 tessuto grigio di serie
stoffa cliente (3 MT) COD. 001186 - custom cat.B COD. 001298

COD. 00490 tessuto grigio di serie
stoffa cliente (2 MT) COD. 00990 - custom cat.B COD. 001070

COD. 00190 tessuto grigio di serie
stoffa cliente (1,5 MT) COD. 00430 - custom cat.B COD. 00490





Art. 386 Juliette Lounge

CUSTOMIZZABILE

- ORDINE MINIMO 4 PZ. - TEMPI 40 GG
- VELLUTO NON IGNIFUGO COD. 00580
- STOFFA CLIENTE (1,8 MT) COD. 00520
- SUPPLEMENTO PER GOMMA IGNIFUGA + 15,00
Velluto ignifugo + € 50,00 (ordine min. 10 pz.)
- STRUTTURA VERNICIATA nera

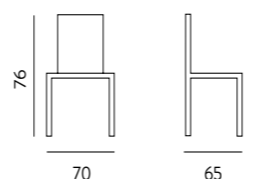

CUSTOMIZZABILE

Art. 385 Jorgette

poltrona lounge

stoffa CAT. B COD. 001130
stoffa cliente (3 mt) COD. 001090

TEMPI 30 gg.

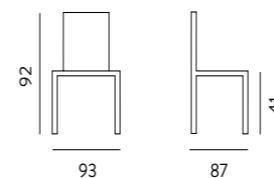



Art. 394 Candy

- IMBALLO N. 1 pz.
- **NORMALMENTE IN PRONTA CONSEGNA**
- GAMBE MASSELLO DI FAGGIO TINTO NATURALE
STRUTTURA POLIPROPILENE

- PP **BIANCO** / TESSUTO **GRIGIO** COD. 00398
- PP **GRIGIO** / TESSUTO **GRIGIO** COD. 00398
- PP **CELESTE** / TESSUTO **CELESTE** COD. 00398
- stoffa cliente (1,2 MT) COD. 00558 - custom cat.B COD. 00638

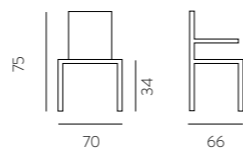

Art. 396 Candy pouf

- IMBALLO N. 1 pz.
- **NORMALMENTE IN PRONTA CONSEGNA**
- GAMBE MASSELLO DI FAGGIO TINTO NATURALE

- TESSUTO **GRIGIO** COD. 00189
- TESSUTO **CELESTE** COD. 00189
- stoffa cliente (0,8 MT) COD. 00229 - custom cat.B COD. 00259

CUSTOMIZZABILE

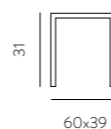



Art. 390 Gretel

- **IMBALLO N. 2 pz.**
Imballo speciale 1 pz. + 10,00 netto
- **NORMALMENTE IN PRONTA CONSEGNA**
- **STRUTTURA METALLO CROMATO**
- **SCOCCA IN POLIPROPILENE BIANCO**
- **CUSCINO SFODERABILE SINTETICO SOFT grigio**

COD. 00480



CUSTOMIZZABILE

stoffa cliente
mt. 2 cad.

COD. 00586

tessuto cat. B
ECOPELLE - VELLUTO

COD. 00658

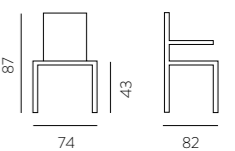



FIRST PRICE

Art. 305 **Cocò**

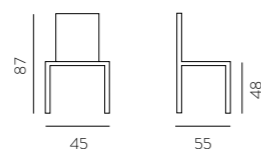

■ IMBALLO N. 4 pz.

■ **NORMALMENTE IN PRONTA CONSEGNA**

■ **STRUTTURA METALLO VERNICIATA NERA**

■ **VELLUTO ANTIMACCHIA:**

nero / puntale verniciato ottone

COD. 00116

nero / gambe tutte nere

COD. 00116

antracite / puntale verniciato silver

COD. 00116

verde bosco / gambe tutte nere

COD. 00116

DISPONIBILI DA MARZO 2025

tortora / gambe nere

COD. 00116

ottanio / gambe nere

COD. 00116

mattone / gambe nere

COD. 00116





Art. 304 Lulù

■ IMBALLO N. 4 pz.

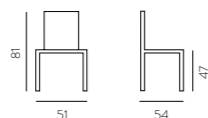

■ **NORMALMENTE IN PRONTA CONSEGNA**

■ **VELLUTO:**

antracite - grigio perla - verde bosco - rosa cipria - tortora

COLORI NEWS: mattone - ottanio

■ **GAMBE VERNICIATE NERE** COD. 00166

■ **GAMBE OTTONE LUCIDO galvanico** COD. 00178

gamba Ø 22 conificata

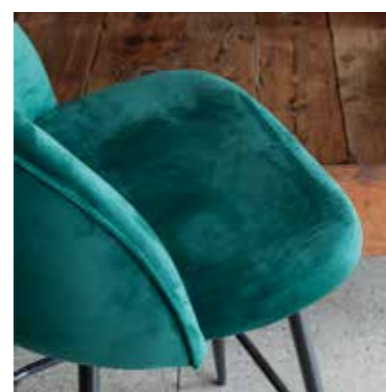

cucitura con PIPING



antracite

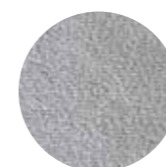

grigio perla



rosa cipria



verde bosco



tortora

NEWS



ottanio



mattone



Il velluto potrebbe presentare effetti che non sono da considerare difettosità in quanto caratteristiche della composizione e del tipo di lavorazione: effetto a macchia o marazzatura, effetto chiaro/scuro, effetto impronta



CUSTOMIZZABILE

stoffa cliente + COD. 0052
mt. 1,2 cad.

tessuto cat. B + COD. 0084
ECOPELLE - VELLUTO

Supplemento gomma ignifuga + € 15,00
supplemento velluto ignifugo + € 20,00
NB: ordine minimo 20 pz.

Art. 506/8



Art. 306 **Musa**

■ **IMBALLO N. 4 pz.**

■ **NORMALMENTE IN PRONTA CONSEGNA**

■ **VELLUTO:**

antracite - verde bosco - rosa cipria

■ **GAMBE VERNICIATE NERE**

COD. 00159

gamba Ø 25 conificata



antracite

verde bosco

rosa cipria

Il velluto potrebbe presentare effetti che non sono da considerare difettosità in quanto caratteristiche della composizione e del tipo di lavorazione: effetto a macchia o marazzatura, effetto chiaro/scuro, effetto impronta

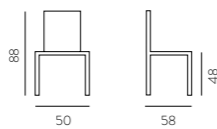

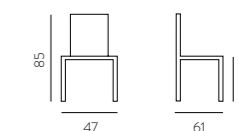
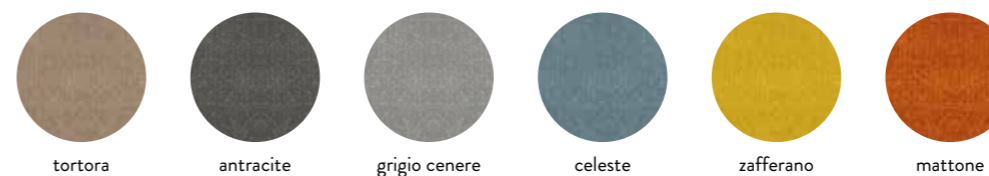

Il velluto potrebbe presentare effetti che non sono da considerare difettosità in quanto caratteristiche della composizione e del tipo di lavorazione: effetto a macchia o marzatura, effetto chiaro/scuro, effetto impronta

Art. 206 **Zara**

■ **IMBALLO N. 4 pz.**
Imballo speciale 1/3 pz. + 10,00 netto

- **NORMALMENTE IN PRONTA CONSEGNA**
- **STRUTTURA METALLO VERNICIATA NERA**
- **VELLUTO ANTIMACCHIA:**
tortora - antracite - grigio cenere
celeste - zafferano - mattone

COD. 00198

CUSTOMIZZABILE

stoffa cliente COD. 00218
mt. 1.5 cad.

tessuto cat. B COD. 00250
ECOPELLE - VELLUTO

Supplemento gomma ignifuga + € 15,00

Supplemento velluto ignifugo + € 20,00

NB: ordine minimo 20 pz.





582 Juliette Stool

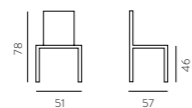

Art. 382 Juliette

- IMBALLO N. 2 pz.
- **NORMALMENTE IN PRONTA CONSEGNA**
- STRUTTURA METALLO VERNICIATA NERO LAMBORGHINI COD. 00228
- VELLUTO ANTIMACCHIA:
grigio fumo - celeste - rosa - verde - ottanio - mattone - giallo
stoffa cliente min 20 pz.

CUSTOMIZZABILE

Il velluto potrebbe presentare effetti che non sono da considerare difettosità in quanto caratteristiche della composizione e del tipo di lavorazione: effetto a macchia o marazzatura, effetto chiaro/scuro, effetto impronta





Art. 266 Priscilla

- IMBALLO N. 4 pz.
- **NORMALMENTE IN PRONTA CONSEGNA
DISPONIBILI DA MARZO 2025**
- STRUTTURA METALLO VERNICIATA NERA
- TESSUTO RICICLABILE: **COD. 00208**
ANTRACITE
TORTORA
VERDE
ARANCIO

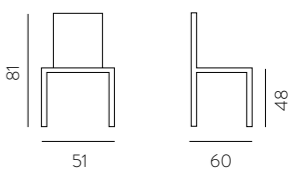

SGABELLO H65
ART. 566 COD. 00278
IMBALLO 1 PZ.



Art. 217 Ginger

- **IMBALLO N. 2 pz.**
Imballo speciale 1 pz. + 10,00 netto

- **NORMALMENTE IN PRONTA CONSEGNA**

- **NERO/VELLUTO*** COD. 00194
accessorio piedino ottone H 8 cm + € 36,00 set 4 pz.

- **OTTONE/VELLUTO*** COD. 00268
ottone lucido a bagno galvanico "MADE IN ITALY"

* **VELLUTO** di serie:
grigio fumo - tortora - senape - arancio - blu - verde
stoffa cliente min 20 pz.

Supplemento stoffa cliente + € 25,00
Supplemento gomma ignifuga + € 15,00
Supplemento velluto ignifugo + € 20,00
NB: ordine minimo 20 pz.

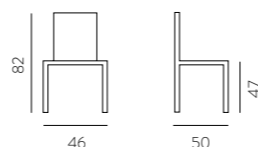

CUSTOMIZZABILE



ACCESSORIO per basi anello ottone H 10 cm

per **Base Como:**
satinato + € 18,00
lucido + € 24,00

per **Base Quadra:**
satinato + € 23,00
lucido + € 29,00



accessorio
piedino ottone



517/8 Ginger Stool



CUSTOMIZZABILE

Mod. Vassily

- IMBALLO N. 1 pz.
- TEMPI 40/50 GG. - ORDINE MINIMO 28 PZ.
- STRUTTURA METALLO VERNICIATA:
NERA - ANTRACITE - BIANCA - CHAMPAGNE

- TESSUTO CAT. B
ECOPELLE - VELLUTO
FAST CLEAN - TESSUTO BOUCLÉ (vedi foto) COD. 00258
- TESSUTO CLIENTE (1 MT.) COD. 00229



Art. 208 Opera

- **IMBALLO N. 4 pz.**
- **NORMALMENTE IN PRONTA CONSEGNA**
- **STRUTTURA METALLO VERNICIATA NERA / PIEDINO OTTONE SATINATO**
- **VELLUTO ANTIMACCHIA:**
sabbia - grigio fumo

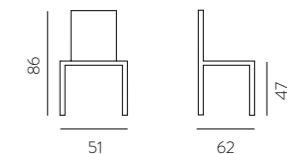

COD. 00246

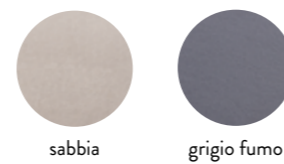

Il velluto potrebbe presentare effetti che non sono da considerare difettosità in quanto caratteristiche della composizione e del tipo di lavorazione: effetto a macchia o marazzatura, effetto chiaro/scuro, effetto impronta

CUSTOMIZZABILE

- **stoffa cliente** COD. 00320
mt. 1,5 cad. da valutare se tessuto è adatto per questo tipo di sedia
- **tessuto cat. B** COD. 00360
VELLUTO

Supplemento gomma ignifuga + € 15,00
Supplemento velluto ignifugo + € 20,00
NB: ordine minimo 20 pz.



cucitura con PIPING





NEWS
OPERA STOOL
vedi settore sgabelli

ACCESSORIO per basi
anello ottone H 10 cm
per Base Como:
satinato + € 18,00
lucido + € 24,00

per Base Quadra:
satinato + € 23,00
lucido + € 29,00





Art. 209 **Barcellona**

- **IMBALLO N. 2 pz.**
Imballo speciale 1 pz. + 10,00 netto
- **NORMALMENTE IN PRONTA CONSEGNA**
- **STRUTTURA METALLO VERNICIATA NERA**
- **ECOPELLE:**
ottanio - titanio COD. 00238
- **VELLUTO ANTIMACCHIA:**
sabbia - grigio fumo - verde COD. 00238

Il velluto potrebbe presentare effetti che non sono da considerare difettosità in quanto caratteristiche della composizione e del tipo di lavorazione:
effetto a macchia o marazzatura, effetto chiaro/scuro, effetto impronta



CUSTOMIZZABILE

stoffa cliente + COD. 0072
mt. 1,4 cad.

tessuto cat. B + COD. 00107
ECOPELLE - VELLUTO

Supplemento velluto ignifugo + € 20,00
NB: ordine minimo 20 pz.

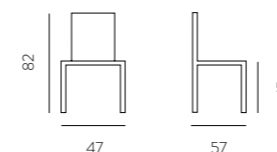



■ IMBALLO N. 2 pz.

■ **NORMALMENTE IN PRONTA CONSEGNA**

■ BASE 4 GAMBE VERNICIATA NERA

■ ECOPELLE, SEDILE LISCIA / SCHIENALE STAMPATO A RILIEVO:

tortora chiaro - nocciola - titanio

COD. 00248

NB: SOLO ECOPELLE DI SERIE

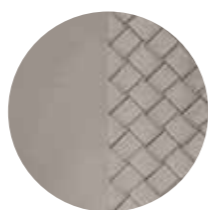
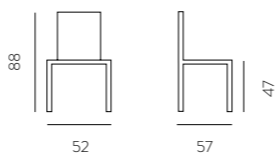

tortora chiaro



nocciola



grigio titanio





Art. 379 Pigalle Uno RECYCLE

QUESTA VERSIONE SOLO CON TESSUTO DI SERIE,
CUSTOM VEDI ART. 380

- IMBALLO N. 2 pz.
Imballo speciale 1 pz. + 10,00 netto
- **NORMALMENTE IN PRONTA CONSEGNA
DISPONIBILI DA MARZO 2025**
- STRUTTURA METALLO VERNICIATA **NERA**
- TESSUTO RICICLABILE: **COD. 00246**
ANTRACITE
TORTORA
VERDE
ARANCIO

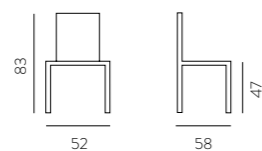



Art. 379 Pigalle Uno CASA

QUESTA VERSIONE SOLO CON TESSUTO DI SERIE, CUSTOM VEDI ART. 380 pag. dopo

- IMBALLO N. 2 pz.
Imballo speciale 1 pz. + 10,00 netto

■ **NORMALMENTE IN PRONTA CONSEGNA**

■ STRUTTURA METALLO VERNICIATA **NERA**

■ VELLUTO ANTIMACCHIA:

tortora - antracite - verde

COD. 00246

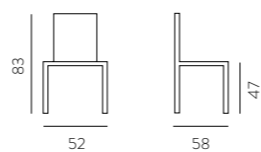

tortora

antracite

verde

Il velluto potrebbe presentare effetti che non sono da considerare difettosità in quanto caratteristiche della composizione e del tipo di lavorazione: effetto a macchia o marazzatura, effetto chiaro/scuro, effetto impronta





semipoltroncina Art. 380 Pigalle Uno CUSTOM

VELLUTO SCHIENALE TRAPUNTATO
COD. 00320 ordine min. 12 pz.

■ TEMPI 30 GG.

■ GAMBE METALLO VERNICIATA: NERA - SUPPLEMENTO BRONZO + € 12,00

■ Velluto: giallo - mattone - rosa - ottanio - verde

COD. 00280

■ Tessuto bouclé - ecopelle VARI COLORI

COD. 00290

■ Stoffa cliente (1,5 mt)

COD. 00220

■ Supplemento gomma ignifuga + € 15,00 / supplemento velluto ignifugo + € 20,00 NB: ordine minimo 20 pz.

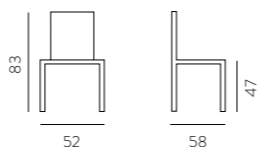

CUSTOMIZZABILE

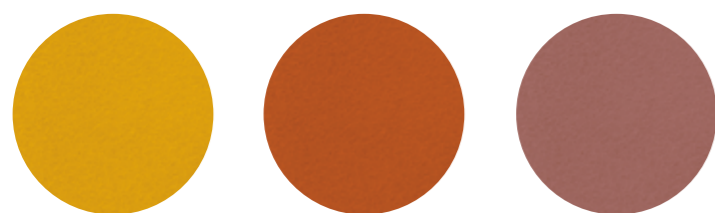

24 giallo

26 mattone

29 rosa



19 ottanio

20 verde



Tessuto bouclé
gamba bronzo

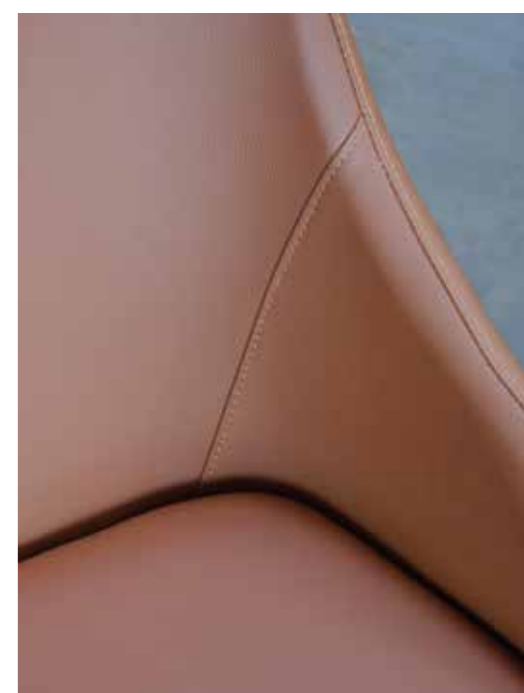



poltroncina Art. 381 Pigalle Due

■ IMBALLO N. 1 pz.

■ TEMPI 30 GG.

■ STRUTTURA METALLO VERNICIATA **NERA** - SUPPLEMENTO BRONZO + € 12,00

■ Velluto: **giallo** - **mattone** - **rosa** - **ottanio** - **verde** COD. 00295

■ Tessuto bouclé - ecopelle VARI COLORI COD. 00305

■ Stoffa cliente (1,5 mt) COD. 00235

■ Supplemento gomma ignifuga + € 15,00 / supplemento velluto ignifugo + € 20,00 NB: ordine minimo 20 pz.

CUSTOMIZZABILE

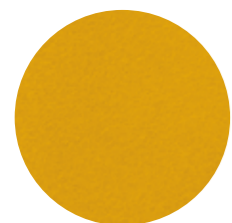
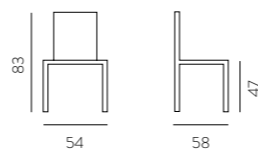

24 giallo

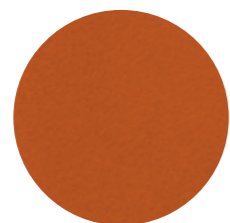

26 mattone

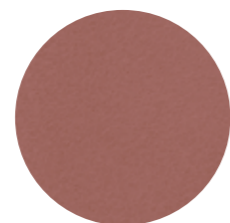

29 rosa



19 ottanio



20 verde





Art. 264 Penelope **Recycle**

- IMBALLO N. 2 pz.
- **NORMALMENTE IN PRONTA CONSEGNA**
- STRUTTURA METALLO VERNICIATA NERA



- TESSUTO RICICLABILE: **COD. 00249**
 ANTRACITE
 TORTORA
 VERDE
 ARANCIO

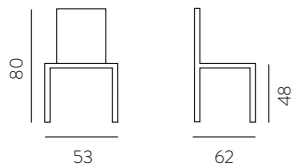



CUSTOMIZZABILE

Art. 264 Penelope Custom

- IMBALLO N. 1 pz.
- TEMPI 30/40 GG. - ORDINE MINIMO 8 PZ.
- STRUTTURA METALLO VERNICIATA NERA
- TESSUTO CAT. B COD. 00267
 ECOPELLE - VELLUTO
 FAST CLEAN - TESSUTO BOUCLÉ (vedi foto)
- TESSUTO CAT. C COD. 00298
 AQUACLEAN
- TESSUTO CLIENTE (1,5 MT.) COD. 00218

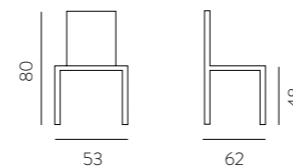



Art. 260 Artemisia

- IMBALLO N. 1 pz.
- **NORMALMENTE IN PRONTA CONSEGNA**
- STRUTTURA METALLO
VERNICIATA **NERA**
- Velluto a coste antracite
COD. 00280

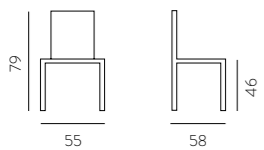

Ecopelle colori di serie:

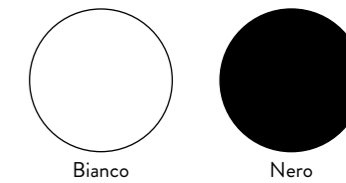

Ecopelle colori speciali:

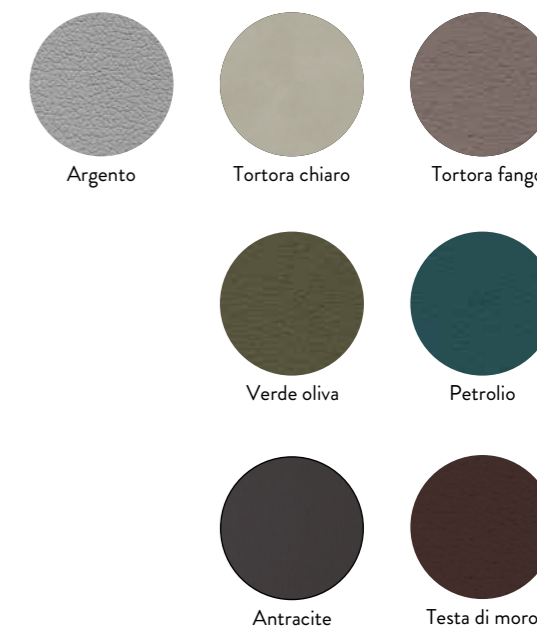

CUSTOMIZZABILE

Art. 378 Moon

- IMBALLO N. 1 pz.
- GAMBE: **CROMATE - NERE**
- **NORMALMENTE IN PRONTA CONSEGNA**
- ECOPELLE: bianco - nero COD. 00410
- ECOPELLE SPECIAL **30 GG** COD. 00440
- STOFFA CLIENTE:
150x140 cm 30 GG COD. 00380

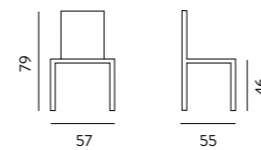



**OTTONE
GALVANICO LUCIDO**

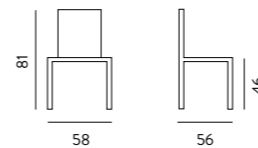

Art. 327 Lynne

■ **STOFFA CUSTOM CAT. B - ORDINE MINIMO 30 PZ. - TEMPI CIRCA 40 GG.
PRODOTTO ARTIGIANALE**

- STRUTTURA VERNICIATA: NERA - BIANCA
- STRUTTURA OTTONE GALVANICO LUCIDO

COD. 00392
COD. 00456

CUSTOMIZZABILE



Art. 211/CS Cabiria custom

- **ORDINE MINIMO 4 PZ.**
SOTTO 4 PZ. GESTIONE TECNICA € 30,00 netti
TEMPI 30 GG

- **STRUTTURA METALLO VERNICIATA NERA**
- **VELLUTO ANTIMACCHIA** COD. 00391
- **AQUACLEAN** COD. 00430
- **STOFFA CLIENTE (1,5 MT)** COD. 00359

Il velluto potrebbe presentare effetti che non sono da considerare difettosità in quanto caratteristiche della composizione e del tipo di lavorazione: effetto a macchia o marazzatura, effetto chiaro/scuro, effetto impronta



CUSTOMIZZABILE

Supplemento velluto ignifugo + € 20,00
NB: ordine minimo 20 pz.

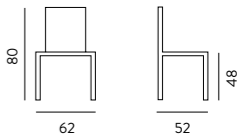

Art. 211/4G Cabiria 4G

- **IMBALLO N. 1 pz. - SOLO CON TESSUTI DI SERIE**
- **NORMALMENTE IN PRONTA CONSEGNA**
- **BASE 4 GAMBE VERNICIATA NERA**
- **ECOPELLE: tortora fango - titanio** COD. 00338
- **VELLUTO ANTIMACCHIA grigio cenere** COD. 00338

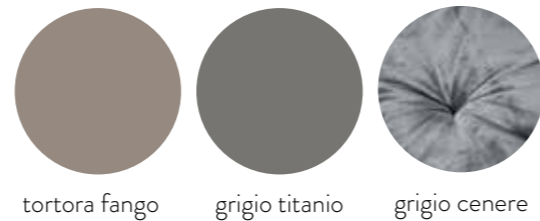

tortora fango

grigio titanio

grigio cenere





Art. 253/CS Carnaby custom

- **ORDINE MINIMO 4 PZ.**
SOTTO 4 PZ. GESTIONE TECNICA € 30,00 netti
TEMPI 30 GG

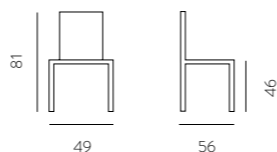

- **STRUTTURA METALLO VERNICIATA NERA**

- **ECOPELLE CAT. B** COD. 00320
- **VELLUTO ANTIMACCHIA** COD. 00320
- **STOFFA CLIENTE (1,5 MT)** COD. 00280

Supplemento velluto ignifugo + € 20,00

NB: ordine minimo 20 pz.

CUSTOMIZZABILE

Art. 253/4G Carnaby 4G

- **IMBALLO N. 2 pz. - SOLO CON TESSUTI DI SERIE**
Imballo speciale 1 pz. + 10,00 netto

- **NORMALMENTE IN PRONTA CONSEGNA**
- **BASE 4 GAMBE VERNICIATA NERA**
- **ECOPELLE: tortora fango - titanio** COD. 00216
- **VELLUTO ANTIMACCHIA grigio cenere** COD. 00216

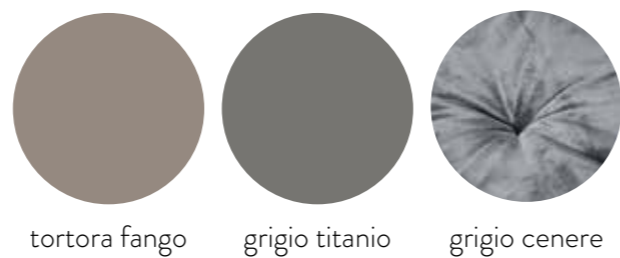

tortora fango

grigio titanio

grigio cenere



Il velluto potrebbe presentare effetti che non sono da considerare difettosità in quanto caratteristiche della composizione e del tipo di lavorazione: effetto a macchia o marazzatura, effetto chiaro/scuro, effetto impronta



VERSIONE UNICOLOR

VERSIONE NABUK

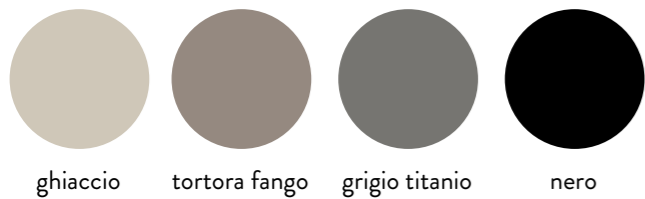

ghiaccio tortora fango grigio titanio nero

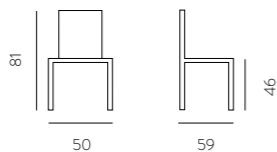

Art. 210 Norway

- IMBALLO N. 2 pz.
- **NORMALMENTE IN PRONTA CONSEGNA**
- STRUTTURA METALLO VERNICIATA IN TINTA
- SEDILI ECOPELLE:
ghiaccio - tortora fango - titanio - nero



COD. 00228

- STRUTTURA METALLO VERNICIATA NERA
- SEDILI ECO NABUK: beige - grigio

COD. 00228

CUSTOMIZZABILE solo base nera

stoffa cliente COD. 00265
mt. 1,5 cad.

tessuto cat. B COD. 00297
ECOPELLE - VELLUTO

Supplemento gomma ignifuga + € 15,00
Supplemento velluto ignifugo + € 20,00
NB: ordine minimo 20 pz.





Art. 240 Sinfonia

- IMBALLO N. 4 pz.
Imballo speciale 1/3 pz. + 10,00 netto
- **NORMALMENTE IN PRONTA CONSEGNA**
- STRUTTURA METALLO
- GAMBE RIVESTITE ECOPELLE: bianco-sabbia
- GAMBE VERNICIATE IN TINTA ECOPELLE: titanio

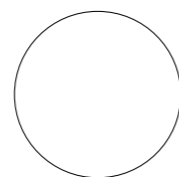

bianco



sabbia

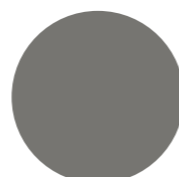

grigio titanio

COD. 00208

COD. 00208

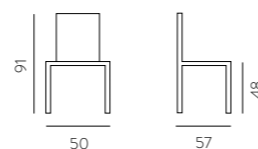

CUSTOMIZZABILE gamba verniciata **nera** - TEMPI 40 GG.

tessuto cat. B
ECOPELLE - VELLUTO

COD. 00301

stoffa cliente
mt. 1,5 cad.

COD. 00268

Supplemento velluto ignifugo + € 20,00
NB: ordine minimo 20 pz.



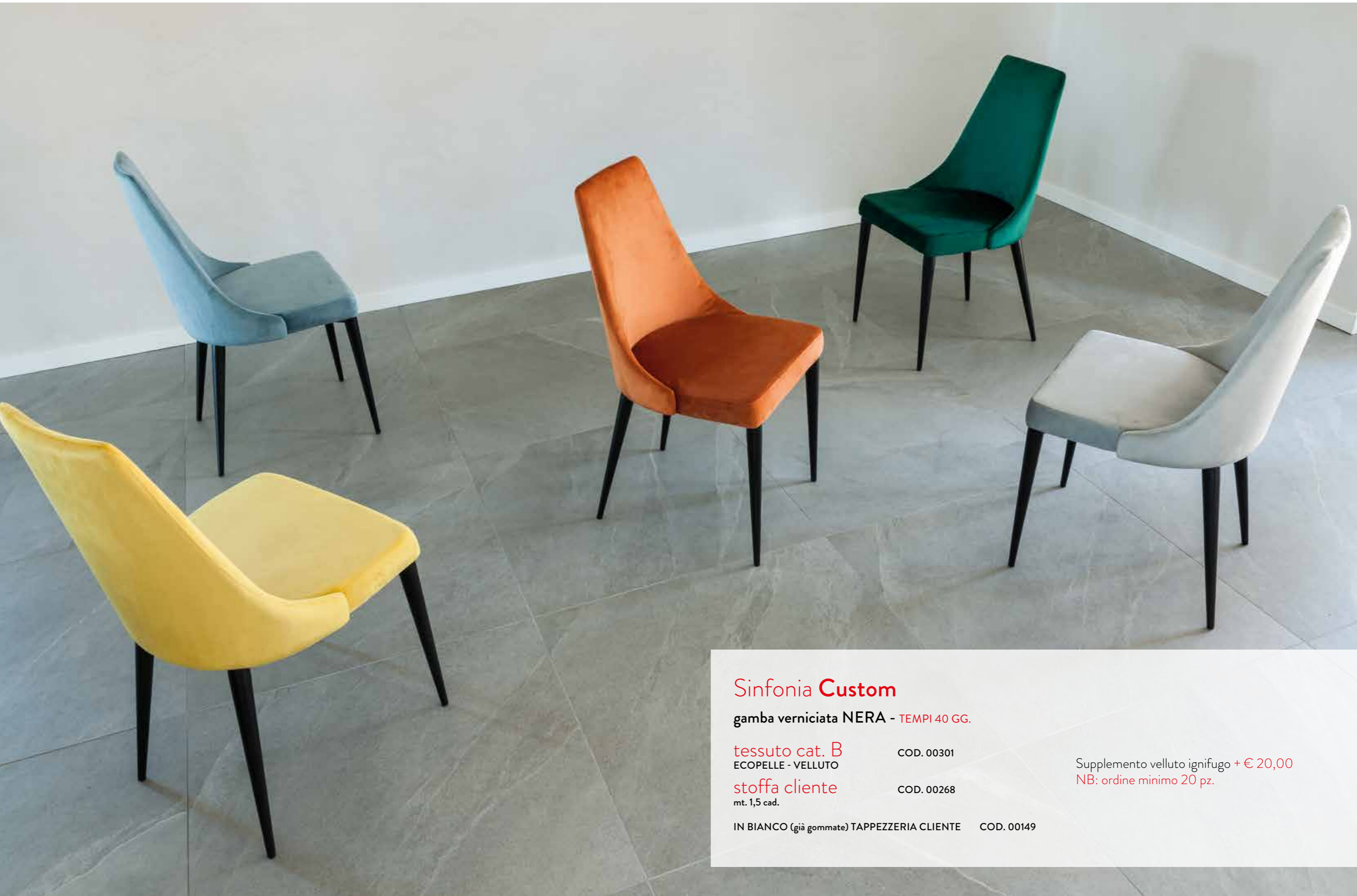

Sinfonia **Custom**

gamba verniciata NERA - TEMPI 40 GG.

tessuto cat. B
ECOPELLE - VELLUTO

COD. 00301

stoffa cliente
mt. 1,5 cad.

COD. 00268

IN BIANCO (già gommate) TAPPEZZERIA CLIENTE COD. 00149

Supplemento velluto ignifugo + € 20,00
NB: ordine minimo 20 pz.

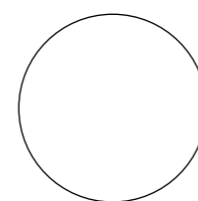

bianco



sabbia

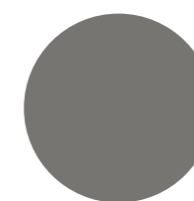

grigio titanio

La tinta delle gambe, essendo materiale naturale, può variare da partita a partita

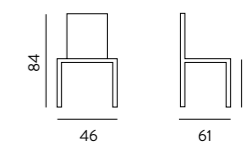

Art. 130 Finland

- IMBALLO N. 4 pz.
- **NORMALMENTE IN PRONTA CONSEGNA**
- GAMBE:
MASSELLO TINTO: naturale - noce medio
- SEDILE:
ECOPELLE: bianca - sabbia - titanio

COD. 00206

CUSTOMIZZABILE

stoffa cliente COD. 00265
mt. 1,3 cad.

tessuto cat. B COD. 00297
ECOPELLE - VELLUTO

Supplemento gomma ignifuga + € 15,00
Supplemento velluto ignifugo + € 20,00
NB: ordine minimo 20 pz.





Art. 250 Diva

- IMBALLO N. 4 pz.
- STRUTTURA METALLO
- GAMBE FRASSINO MASSELLO TINTO NOCE MEDIO

▪ ecopelle sabbia / bordino caffè COD. 00258
NORMALMENTE IN PRONTA CONSEGNA

CUSTOMIZZABILE

▪ cat.B COD. 00387
TEMPI CIRCA 40 GG.

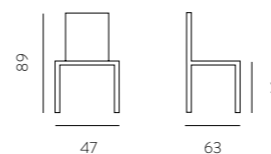

ecopelle sabbia / bordino caffè
NORMALMENTE IN PRONTA CONSEGNA

DANUBIO collection

STOFFE vedi lato

VERSIONE CUSTOM Ordine minimo 36 pz.

Anche colori misti

NO STOFFA CLIENTE



GAMBE **ROVERE MASSELLO** TINTE:
noce canaletto - rovere - anilina nera

ECOPELLE LION

VELLUTO DAVIS RIVIERA

BOUCLÈ DAVIS

Supplemento gomma ignifuga / ecopelle + € 25,00
Supplemento gomma ignifuga / velluto + € 30,00



Art. 148 Amanda

GAMBE **ROVERE MASSELLO** TINTE:
noce canaletto - rovere - anilina nera

**NORMALMENTE IN PRONTA CONSEGNA
NO MINIMO ORDINE**

VELLUTO DAVIS COD. 00238
grigio 91 - antracite 95
tortora chiaro 16 - brown 26
verde pistacchio 36 - senape 41 - mattone 51

COLORI NEWS IN PRONTA CONSEGNA
VELLUTO DAVIS ottanio 76 COD. 00258
ECOPELLE LION: COD. 00258
cuoio 305 - titanio 020

VERSIONE CUSTOM NB: ordine minimo 36 pz.

VELLUTO A CAMPIONARIO COD. 00258
ECOPELLE COD. 00258
BOUCLÈ COD. 00268

TEMPI 50/60 GG.

VEDI PAG. DOPO

TOP SELLER

L51-P55-HS48-HT89

DANUBIO
collection



Art. 148 Amanda

GAMBE **ROVERE MASSELLO** TINTE:
noce canaletto - rovere - anilina nera

L51-P55-HS48-HT89

NORMALMENTE IN PRONTA CONSEGNA
NO MINIMO ORDINE

VELLUTO DAVIS COD. 00238

grigio 91 - antracite 95

tortora chiaro 16 - brown 26

verde pistacchio 36 - senape 41 - mattone 51

COLORI NEWS IN PRONTA CONSEGNA

VELLUTO DAVIS ottanio 76 COD. 00258

ECOPELLE LION: COD. 00258

cuoio 305 - titanio 020

VERSIONE CUSTOM NB: ordine minimo 36 pz.

VELLUTO A CAMPIONARIO COD. 00258

ECOPELLE COD. 00258

BOUCLÈ COD. 00268

TEMPI 50/60 GG.

DANUBIO collection





Art. 148 Amanda

COLORI NEWS IN PRONTA CONSEGNA

VELLUTO DAVIS ottanio 76

COD. 00258

ECOPELLE LION: cuoio 305 - titanio 020

COD. 00258

GAMBE
ROVERE MASSELLO TINTE:
noce canaletto
rovere
anilina nera

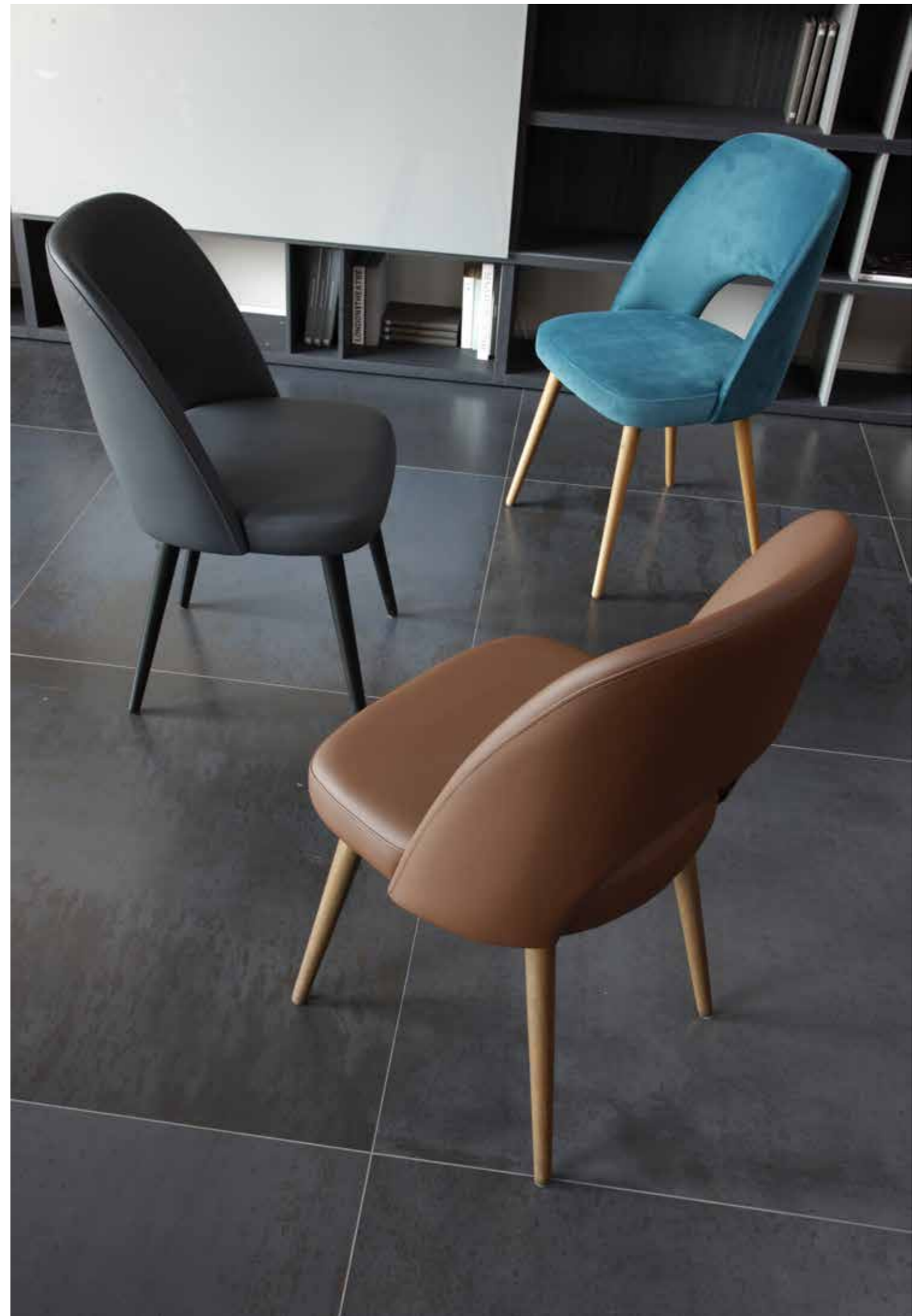



DANUBIO collection

Art. 154 Brooke Chair

GAMBE **ROVERE MASSELLO** TINTE:
noce canaletto - rovere - anilina nera

L53-P52-HS49-HT91

**NORMALMENTE IN PRONTA CONSEGNA
NO MINIMO ORDINE**

VELLUTO DAVIS : COD. 00268
tortora chiaro 16 - antracite 95

ECOPELLE LION: COD. 00268
cuoio 305 - titanio 020

VERSIONE CUSTOM NB: ordine minimo 36 pz.

VELLUTO COD. 00268
ECOPELLE COD. 00268
BOUCLÉ COD. 00278
TEMPI 50/60 GG.



Brooke Stool H 65 - H 75
vedi settore sgabelli



DANUBIO collection



North Chair

GAMBE **ROVERE MASSELLO** TINTE:
noce canaletto - rovere - anilina nera

L49-P52-HS49-HT86

VELLUTO	COD. 00258
ECOPELLE	COD. 00258
BOUCLÈ	COD. 00268

NB: ordine minimo 36 pz.

TEMPI 50/60 GG.



North Stool

POGGIAPIEGI IN METALLO NERO

H 65 - H 75 + €10,00

VELLUTO	COD. 00338
ECOPELLE	COD. 00338
BOUCLÈ	COD. 00348

TEMPI 50/60 GG.

L50-P54-HS65/75-HT100/110





Art. 150 Brunilde

senza foro

**NORMALMENTE IN PRONTA CONSEGNA
NO MINIMO ORDINE**

GAMBE **ROVERE MASSELLO** TINTE:
noce canaletto - rovere - anilina nera

VELLUTO DAVIS : tortora chiaro 16 - antracite 95

COD. 00278

ECOPELLE LION: cuoio 305 - titanio 020

COD. 00278

BOUCLÈ DAVIS: antracite 92 - sabbia 05

COD. 00288



Brunilde CUSTOM con o senza foro

GAMBE **ROVERE MASSELLO** TINTE:
noce canaletto - rovere - anilina nera

L55-P59-HS50-HT83



VERSIONE CUSTOM

VELLUTO	COD. 00278
ECOPELLE	COD. 00278
BOUCLÈ	COD. 00288

VERSIONE CUSTOM **NB: ordine minimo 36 pz.**

TEMPI 50/60 GG.

DANUBIO collection





STRUTTURA
FAGGIO VARIE TINTE
O AL CAMPIONE

Art. 322 Breakfast XL

TESSUTO CAT. B COD. 00284
STOFFA CLIENTE 1 MT COD. 00248

TEMPI CA 40 GG.
NB: ordine min 20 pz. con acconto

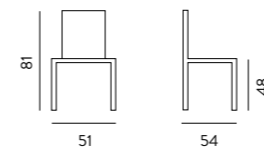

TINTE & STOFFE
A CAMPIONARIO





Piano Art. 1050/29 Vitrum

Art. 321 Breakfast

L43-P48-HS49-HT85

TESSUTO CAT. B COD. 00227

STOFFA CLIENTE 0,80 MT COD. 00208

RIFINITURA IMBOTTITURA SCHIENALE CON PIPING

TEMPI CA 40 GG.

NB: ordine min 20 pz. con acconto

Art. 325 Breakfast Stool

TESSUTO CAT. B
COD. 00326



Imbottitura rifinita
con cordino Piping





SEDILE a COSTINA

SEDILE a SAPONETTA



EXCLUSIVE LINE

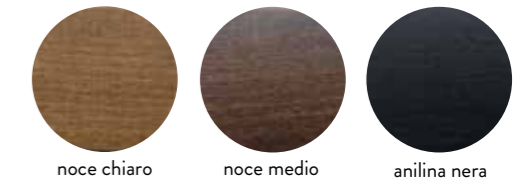

STRUTTURA
FAGGIO VARIE TINTE
O AL CAMPIONE



CANNA MIDOLLINO



CANNA CLASSICA

Art. 329 Brighton

- IMBALLO N. 2 pz.
- ORDINE MINIMO 30 PZ - TEMPI 40/50 GG

TESSUTO CAT. B COD. 00296
STOFFA CLIENTE 0,6 MT COD. 00278

Scegliere tipo di Canna (schienale) e
tipo di sedile (saponetta o costina)

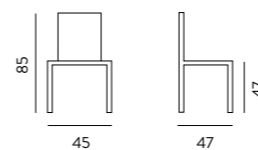



Mod. **Lugano**

TESSUTO CAT. B COD. 00289
 STOFFA CLIENTE 1 MT COD. 00272

SEDILE MASSELLO COD. 00279

TEMPI CA 40 GG.
NB: ordine min 48 pz. con acconto



TINTE & STOFFE
 A CAMPIONARIO

STRUTTURA
 FAGGIO VARIE TINTE
 O AL CAMPIONE

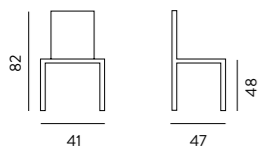
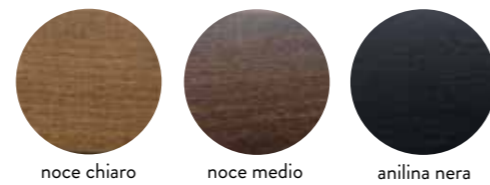

EXCLUSIVE LINE

STRUTTURA FRASSINO

personalizzabile
360

TINTE & ANILINE
A CAMPIONE
NB: ORDINE MINIMO 36 PZ.
TEMPI 50/60 GG.



L45-P52-HS47-HT78

mod. **Arketipo** COD. 00267

Sgabello + €100





Art. 095 *New Age*

- IMBALLO N. 2 pz.
- **NORMALMENTE IN PRONTA CONSEGNA**
- STRUTTURA LACCATO: BIANCO - SABBIA - TITANIO
SEDILE ECOPELLE IN TINTA

NEWS VEDI PAGINA DOPO

- STRUTTURA LACCATA NERA / SEDILE STOFFA SALE E PEPE
- STRUTTURA TINTA NOCE / SEDILE ECOPELLE CUOIO

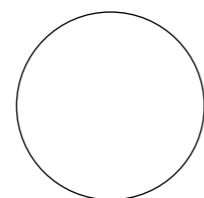

bianco



sabbia

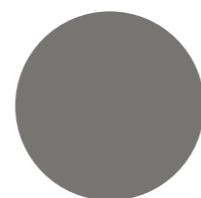

titanio

COD. 00138

COD. 00148

COD. 00148

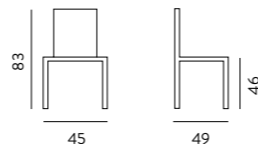

modello
FIRST PRICE



Art. 095 *New Age*

modello
FIRST PRICE

WOOD CONTEMPORARY collection

NB: ordine minimo 12 pz. per tipo colore
tempi 40/50 gg.



TINTE & STOFFE
A CAMPIONARIO



Art. 323 Vyolet

- IMBALLO N. 2 pz.
- **NORMALMENTE IN PRONTA CONSEGNA**
- STRUTTURA FRASSINO TINTO **noce medio**
- SEDILE IMBOTTITO **ecopelle moka** COD. 00197

frassino massello

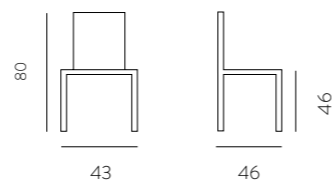

VERSIONE CUSTOM:
SEDILE IMBOTTITO CAT. B

COD. 00227 **TEMPI 40 GG.**
ORDINE MINIMO 20 PZ.

TINTE SU FAGGIO E LACCATURE SOLO PER ARTICOLI

WOOD
CONTEMPORARY
collection

TINTE LEGNO OPACHE

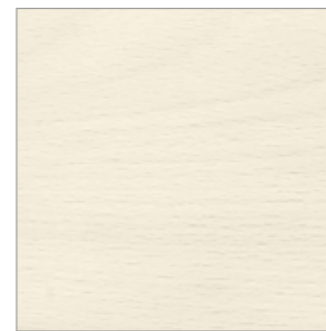

sbiancato **MAH**

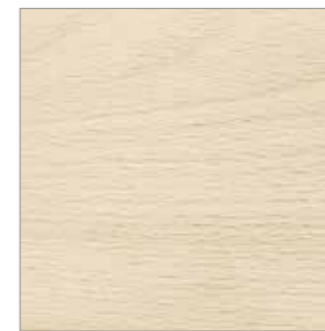

naturale **MNS**



rovere light **MRF**



noce chiaro **M76**



tortora grey **MRH**



noce light **MSS**



noce grey **MTS**



noce medio **M22**



grey light **MC1**



grey medium **M14**



grey dark **MRH**



tinto nero **MCS**

TINTE ANILINA / LEGNO SEMILUCIDE



bianco perla **106**



verde **105**



arancio **MAA**



acquamarina **137**

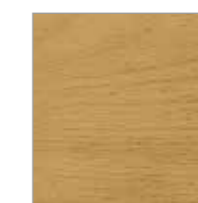

noce chiaro **123**



ciliegio **157**

COLORI LACCATI OPACHI



bianco **141**



beige **BE1**

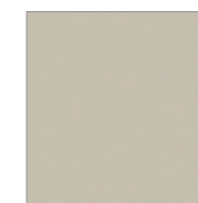

tortora light **FA1**



grigio **LGD**



antracite **LCG**



nero **142**

OPALE family



COLORI LEGNO VEDI PAG.PRIMA

WOOD
CONTEMPORARY
collection
ORDINE MINIMO 20 PZ.
anche assortiti

Art. 324.49E Opale Chair COD. 00366
L48-P58-HS49-HT85



Art. 324.49ER Opale BR Full
L60-P60-HS48-HT85 COD. 00592

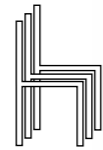

Art. 324.49EP Opale BR Free
L60-P60-HS48-HT85 COD. 00487



Art. 324.49EF Opale Impy COD. 00373
L48-P57-HS49-HT85



Art. 324.49EM COD. 001160
L73-P74-HS40-HT81



Art. 324.49EI Opale Stool COD. 00456
L48-P58-HS81-HT107

Opale sofà



Art. 324.49EN COD. 001790
L141-P74-HS40-HT81



Hotellerie



Mod. Chelsea

L46-P55-HS48-HT97

TESSUTO: VELLUTO - ECOPELLE
VEDI COLLEZIONE DANUBIO

COD. 00168

TEMPI CA 50 GG.
NB: ordine min 38 pz. con acconto



Hotellerie

Mod. Yvonne

L46-P55-HS48-HT97

TESSUTO: VELLUTO - ECOPELLE
VEDI COLLEZIONE DANUBIO

COD. 00153

TEMPI CA 50 GG.
NB: ordine min 38 pz. con acconto



SFODERABILE

OPERAZIONE SEMPLICE E VELOCE (ANCHE PER UN UTENTE, NON ADDETTO AI LAVORI)
GRAZIE A UNO SPECIALE SOTTOTESSUTO TNT CHE RENDE VELOCE L'OPERAZIONE.
bloccaggio con velcro sottosedile

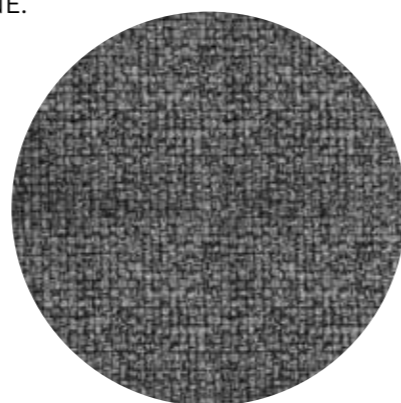

DARK GREY



TAUPE (TORTORA)



TINTE GAMBE



NOCE MEDIO



LACCATO NERO



MOSTAZA (SENAPE)



SKY (CELESTE)

Art. 129 Danimarca

■ **NORMALMENTE IN PRONTA CONSEGNA**

SEDIA COMPLETA COD. 00158

SOLO RIVESTIMENTO COD. 0069



corredate di
vitone tirafondi per
ulteriore robustezza
USO CONTRACT

caratteristiche tessuto
IDROREPELENTE
FACILE DA PULIRE
LAVAGGIO A SECCO MAX 40°
NO CANDEGGIO
NON ASCIUGARE AL SOLE
MARTINDALE 50.000 sfregamenti
EN ISO 12947-2





L'ecopelle nei colori chiari potrebbe macchiarsi a contatto con indumenti non trattati (es. jeans).
Per la pulizia dei prodotti utilizzare solo acqua tiepida e un panno morbido in microfibra.
Non usare solventi o prodotti aggressivi.

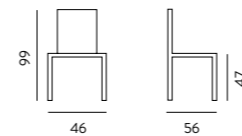

corredate di vitone tirafondi per ulteriore robustezza
USO CONTRACT



Art. 122 Vertigo Slim

- IMBALLO N. 2 pz.
- **NORMALMENTE IN PRONTA CONSEGNA**
- STRUTTURA LACCATO IN TINTA
- SEDILI

ECOPELLE: bianco - sabbia - titanio - grigio ghiaccio
STRUTTURA laccata in tinta

COD. 00117 (con cover COD. 00215)

ECOPELLE: testa di moro/STRUTTURA wengè

COD. 00117 (con cover COD. 00215)



Art. 126 Cover

solo per Art. 122/116
COTONE QUALITY

COD. 0098 solo cover



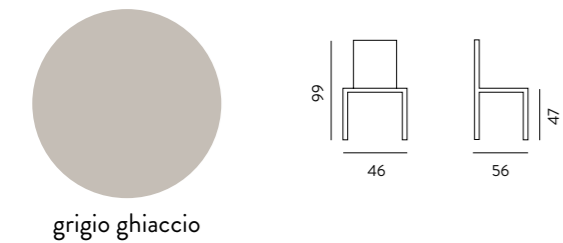

corredate di vitone tirafondi per ulteriore robustezza

Art. 116 Class

- IMBALLO N. 2 pz.
- **NORMALMENTE IN PRONTA CONSEGNA**
- STRUTTURA: LACCATO IN TINTA
- SEDILI
ECOPELLE grigio ghiaccio COD. 00128



L'ecopelle nei colori chiari potrebbe macchiarsi a contatto con indumenti non trattati (es. jeans). Per la pulizia dei prodotti utilizzare solo acqua tiepida e un panno morbido in microfibra. Non usare solventi o prodotti aggressivi.

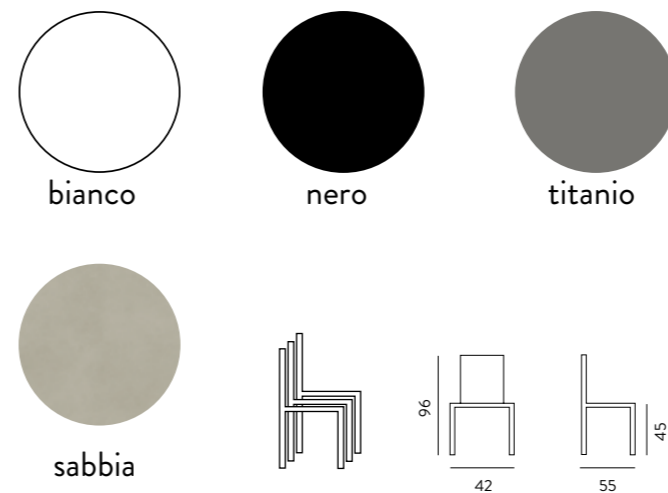

Art. 232 Vanity

- IMBALLO N. 4 pz.
- **NORMALMENTE IN PRONTA CONSEGNA**
- STRUTTURA METALLO RIVESTITO SIMILCUOIO PVC:
bianco - nero - titanio - sabbia COD. 00158





CUSTOMIZZABILE
minimo 40 pz.

Supplemento gomma ignifuga + € 15,00
Supplemento velluto ignifugo + € 20,00



Art. 215 **Hellen Plus**

- IMBALLO N. 4 pz.
- **NORMALMENTE IN PRONTA CONSEGNA**
- **STRUTTURA VERNICIATA NERA**
- **SEDILI**
ECOPELLE titanio
- VELLUTO ANTIMACCHIA:
grigio fumo - tortora - verde - ottanio - blu

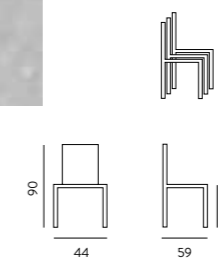

COD. 00187

COD. 00187



Il velluto potrebbe presentare effetti che non sono da considerare difettosità in quanto caratteristiche della composizione e del tipo di lavorazione: effetto a macchia o marazzatura, effetto chiaro/scuro, effetto impronta

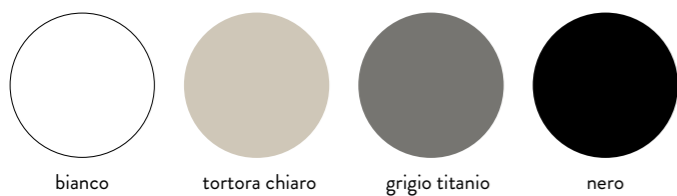

bianco tortora chiaro grigio titanio nero

L'ecopelle nei colori chiari potrebbe macchiarsi a contatto con indumenti non trattati (es. jeans). Per la pulizia dei prodotti utilizzare solo acqua tiepida e un panno morbido in microfibra. Non usare solventi o prodotti aggressivi.

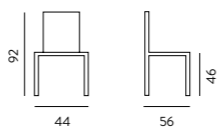

Art. 213 Hellen Classic

■ IMBALLO N. 4 pz.

■ **NORMALMENTE IN PRONTA CONSEGNA**

■ STRUTTURA:	ECOPELLE IN TINTA	VERNICIATA IN TINTA
■ SEDILI		
ECOPELLE: bianco - nero	-	COD. 00167
ECOPELLE: tortora chiaro - grigio titanio	COD. 00167	-





ECONABUK
FAST CLEAN IDROREPELENTE



SCARICA QR
PER LE INCREDIBILI PERFORMANCE

ECONABUK
FAST CLEAN IDROREPELENTE



Art. 219 Cloe Plus

- IMBALLO N. 4 pz.
- **NORMALMENTE IN PRONTA CONSEGNA**
- STRUTTURA METALLO RICOPERTA
- SEDILI

ECONABUK **FAST CLEAN**: antracite - ghiaccio - tortora - kiwi - mattone - senape - celeste COD. 00178

CUSTOMIZZABILE

CON UN MINIMO D'ORDINE 40 PZ.

A RICHIESTA CON **GAMBE VERNICIATE**
VARI COLORI (NON RICOPERTE)
TESSUTO A CAMPIONARIO

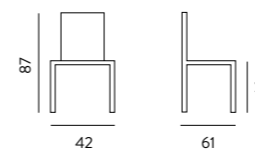



GAMBE METALLO
IN TINTA

Art. 220 Naked

■ **IMBALLO N. 4 pz.**
Imballo speciale 1/3 pz. + 10,00 netto

■ **NORMALMENTE IN PRONTA CONSEGNA**

■ **STRUTTURA METALLO VERNICIATA IN TINTA**

■ **SEDILI**
ECOPELLE:
tortora chiaro - tortora fango - titanio

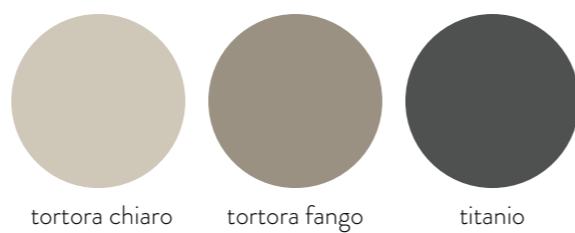

tortora chiaro

tortora fango

titanio

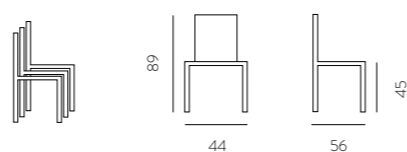

COD. 00163

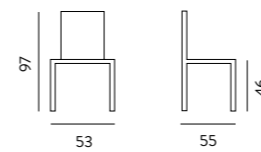

Art. 028 Regina

- **IMBALLO N. 2 pz.**
Imballo speciale 1 pz. + 10,00 netto
- **NORMALMENTE IN PRONTA CONSEGNA**
- **STRUTTURA:**

	POLICARBONATO
trasparente	COD. 00196
fumè	ELIMINATA

PRODOTTI IN POLICARBONATO
Data la particolare tecnologia di questo articolo il prodotto potrebbe presentare dei segni superficiali, queste particolarità non riducono le caratteristiche di estetica e resistenza del prodotto.

Avvertenze e manutenzione:
pulire con panno morbido, non abrasivo, imbevuto di sola acqua
Non usare:
solventi, sgrassanti, alcool etilico e detersivi
(perchè tendono a cristallizzare, facendo perdere le capacità di flessibilità e alta resistenza al prodotto)





Art. 033/6 Rainbow

■ IMBALLO N. 4 pz.
Imballo speciale 1/3 pz. + 10,00 netto

■ **NORMALMENTE IN PRONTA CONSEGNA**

■ STRUTTURA:
POLICARBONATO

trasparente

COD. 00134

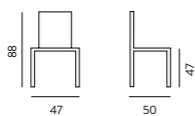

Poltroncina Art. 033/2 Ink-B

■ IMBALLO N. 4 pz.
Imballo speciale 1/3 pz. + 10,00 netto

■ **NORMALMENTE IN PRONTA CONSEGNA**

■ STRUTTURA:
POLICARBONATO

trasparente - fumè

COD. 00196

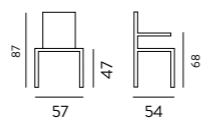

Sedia Art. 033/1 Ink versione fumè

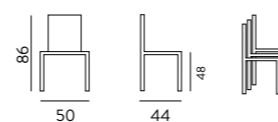

Art. 033/1 Ink

■ IMBALLO N. 4 pz.
Imballo speciale 1/3 pz. + 10,00 netto

■ **NORMALMENTE IN PRONTA CONSEGNA**
■ STRUTTURA POLICARBONATO

trasparente

COD. 00149

trasparente fumè

COD. 00158

VERSIONE IGNIFUGA

ordine min. 20 pz. anche misti
Imballo 4 pz. - TEMPI 20/30 GG.

sedia Art. 033/1 IG COD. 00178
colori: trasparente - bianco lucido

poltroncina Art. 033/2 IG COD. 00209
colori: trasparente



Sgabello 544 Ink Stool - H 65 / 74

PRODOTTI IN POLICARBONATO
Data la particolare tecnologia di questo articolo il prodotto potrebbe presentare dei segni superficiali, queste particolarità non riducono le caratteristiche di estetica e resistenza del prodotto.

Avvertenze e manutenzione:
pulire con panno morbido, non abrasivo, imbevuto di sola acqua
Non usare:
solventi, sgrassanti, alcool etilico e detersivi (perchè tendono a cristallizzare, facendo perdere la capacità di flessibilità e alta resistenza al prodotto)

carrello
Art. 1400.2943
Imballo 2 pz.
COD. 00215

maniglione
Art. 1400.2947
COD. 0060

Porta 12 sedie





Art. 029 Voilà

- **IMBALLO N. 4 pz.**
Imballo speciale 1/3 pz. + 10,00 netto
- **NORMALMENTE IN PRONTA CONSEGNA**
- **STRUTTURA:** POLICARBONATO
- **SEDILI**
trasparente COD. 00176

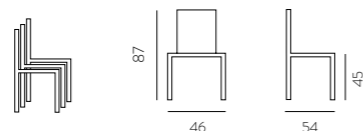

PRODOTTI IN POLICARBONATO
Data la particolare tecnologia di questo articolo il prodotto potrebbe presentare dei segni superficiali, queste particolarità non riducono le caratteristiche di estetica e resistenza del prodotto.

Avvertenze e manutenzione:
pulire con panno morbido, non abrasivo, imbevuto di sola acqua
Non usare:
solventi, sgrassanti, alcool etilico e detersivi (perchè tendono a cristallizzare, facendo perdere la capacità di flessibilità e alta resistenza al prodotto)



Art. 037/1 Valery-S

- **IMBALLO N. 4 pz.**
Imballo speciale 1/3 pz. + 10,00 netto
- **NORMALMENTE IN PRONTA CONSEGNA**
- **STRUTTURA:** POLICARBONATO
- trasparente COD. 00149
- trasparente fumè COD. 00149
- trasparente **ignifugo*** COD. 00178

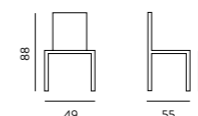

*** VERSIONE IGNIFUGA**
ordine min. 20 pz. anche misti
TEMPI 20/30 GG. (no apertura imballo)



Art. 037/2 Valery-P

- **IMBALLO N. 2 pz.**
Imballo speciale 1 pz. + 10,00 netto
- **NORMALMENTE IN PRONTA CONSEGNA**
- **STRUTTURA:** POLICARBONATO
- trasparente COD. 00167
- trasparente fumè COD. 00167
- trasparente **ignifugo*** COD. 00209

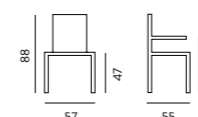



Art. 290 Lotus Wood

- **IMBALLO N. 2 pz.**
Imballo speciale 1 pz. + 10,00 netto
- **NORMALMENTE IN PRONTA CONSEGNA**
- **GAMBE: MASSELLO DI FAGGIO: tinto naturale**
- **SEDILE: POLIPROPILENE: bianco-nero**

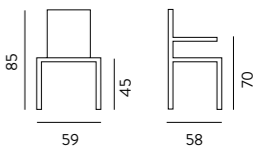

COD. 00189

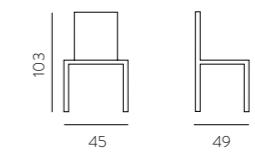

Art. 022 Shell Wood

- **IMBALLO N. 2 pz.**
Imballo speciale 1 pz. + 10,00 netto
- **NORMALMENTE IN PRONTA CONSEGNA**
- **GAMBE:**
MASSELLO DI FAGGIO: tinto naturale
- **SEDILE:**
POLIPROPILENE: bianco - grigio quarzo - nero

COD. 00129

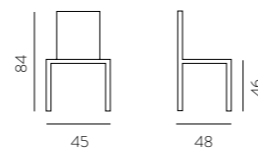

Art. 522 Shell Stool

NB: H SEDILE 65 CM

- **IMBALLO N. 4 pz.**
Imballo speciale 1/3 pz. + 10,00 netto
- **NORMALMENTE IN PRONTA CONSEGNA**
- **GAMBE: MASSELLO DI FAGGIO: tinto naturale**
- **SEDILE:**
POLIPROPILENE: bianco - grigio quarzo - nero

COD. 00166





Art. 03 Idol

- **IMBALLO N. 4 pz.**

Imballo speciale 1/3 pz. + 10,00 netto

- **NORMALMENTE IN PRONTA CONSEGNA**

- **STRUTTURA NERA**

- **SEDILI POLIPROPILENE:**

grigio - nero - senape - ottanio

COD. 00119

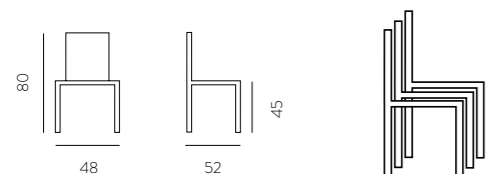



Art. 019 Shell Metal

■ **IMBALLO N. 4 pz.**
Imballo speciale 1/3 pz. + 10,00 netto

■ **NORMALMENTE IN PRONTA CONSEGNA**

■ **STRUTTURA:** CROMATO

■ **SEDILI**
POLIPROPILENE:
bianco - grigio quarzo COD. 00119

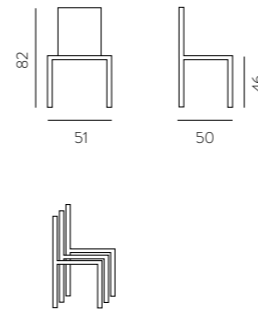

Art. 027 Alina

■ **IMBALLO N. 4 pz.**
Imballo speciale 1/3 pz. + 10,00 netto

■ **NORMALMENTE IN PRONTA CONSEGNA**

■ POLIPROPILENE **BIANCO PANNA**/METALLO BIANCO PANNA
■ POLIPROPILENE **TORTORA**/METALLO BIANCO PANNA
■ POLIPROPILENE **ANTRACITE**/METALLO ANTRACITE

COD. 00129
COD. 00129
COD. 00129

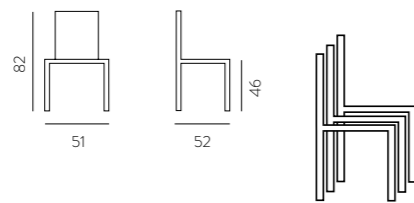

Art. 529 Alina Stool contract H 80

■ **IMBALLO N. 2 pz.** TAX COD. 00196
■ **TEMPI 20/30 GG**



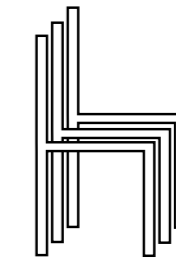

Art. 064 Joy

- IMBALLO N. 4 pz.
- **NORMALMENTE IN PRONTA CONSEGNA**
- **STRUTTURA NERA**
- **SEDILE/SCHIENALE POLIPROPILENE nero** COD. 0089

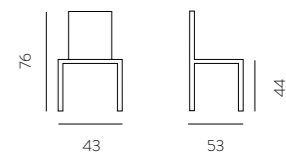

Joy Color COD. 0096

STRUTTURA NERA

SEDILE/SCHIENALE

polipropilene colorato:

ottanio

verde

mattone

tortora

DISPONIBILI DA FEBBRAIO 2025



Art. 020 **Snake** COD. 0069

■ IMBALLO A PILE N. 25 pz. monocolore
ordini sotto 10 pz. + € 20,00

■ **NORMALMENTE IN PRONTA CONSEGNA**
DISPONIBILI DA MARZO 2025

■ **POLIPROPILENE:**
bianco - nero - sabbia
mattone - zafferano - verde oliva - ottanio

INDOOR / OUTDOOR

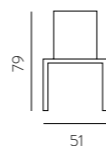
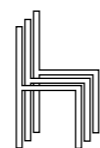



Art. 048 Neos

- **IMBALLO N. 4 pz.**
Imballo speciale 1/3 pz. + 10,00 netto
 - **NORMALMENTE IN PRONTA CONSEGNA**
 - **POLIPROPILENE:**
bianco - grigio avio - nero - tortora
- COD. 0096

ORDINI A STOCK

- **IMBALLO A PILE N. 22 pz. monocolore**
- ordini 2/3 pile COD. 0092
- ordini 4 pile in su COD. 0089

INDOOR / OUTDOOR

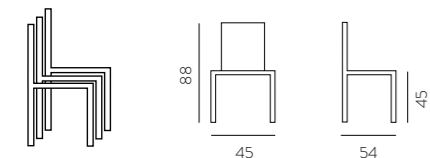



Art. 09 Fly

INDOOR / OUTDOOR

■ IMBALLO N. 4 pz.



- POLIPROPILENE:
- TUTTA: BIANCA - ANTRACITE
- BICOLORE SABBIA / BIANCA
- **NORMALMENTE IN PRONTA CONSEGNA**

COD. 00126

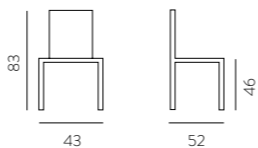

COD. 0096

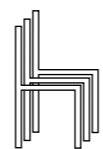

Impilabile 2 pz.

FLY COLOR
STRUTTURA NERA / sedile e schienale:
OTTANIO - VERDE - MATTONE - GIALLO





Art. 075 Amelia

- IMBALLO N. 4 pz.
- POLIPROPILENE ANTRACITE / TESSUTO GRIGIO COD. 00138
- POLIPROPILENE BIANCO / TESSUTO GRIGIO COD. 00138
- POLIPROPILENE TORTORA / TESSUTO TORTORA COD. 00138
- **NORMALMENTE IN PRONTA CONSEGNA
DISPONIBILE DA MARZO 2025**

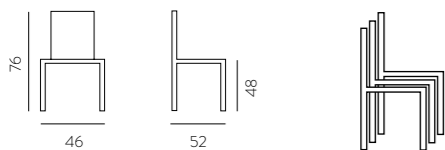



INDOOR / OUTDOOR



Art. 040 Citylife

■ **IMBALLO N. 4 pz.**

Imballo speciale 1/3 pz. + 10,00 netto

■ **NORMALMENTE IN PRONTA CONSEGNA**

■ **POLIPROPILENE:**

COD. 00118

**bianco - grigio - nero - tortora
ottanio - senape - verde**

NB: Gli eventuali segni di stampaggio sono fisiologici, dovuti all'utilizzo del Fiberglass per dare struttura e solidità al prodotto

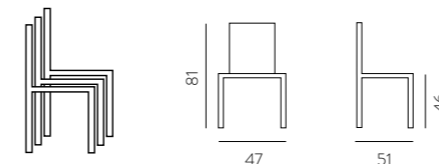

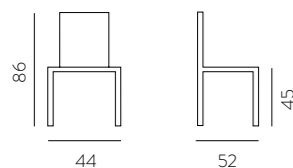

Art. 528 **Stool**
NB: SOLO H65 COD. 00138

fino a 10 pz.

Art. 057 **Vienna 2.0**

- PILE N. 14 pz.
apertura pila + 10,00 netto
- **NORMALMENTE IN PRONTA CONSEGNA**
- **POLIPROPILENE: bianco - sabbia - antracite**

COD. 0098



INDOOR / OUTDOOR



INDOOR / OUTDOOR



Art. 078 **Borgo Antico**

- **IMBALLO PILE N. 14 pz. monocolor**
apertura imballo + 10,00 netto
- **NORMALMENTE IN PRONTA CONSEGNA**
- **RESINA RINFORZATA CON FIBERGLASS:**
bianco - sabbia - nero COD. 0099

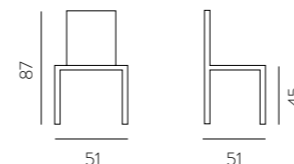

impilabile





sedia appendibile,
pratica e comoda per le pulizie

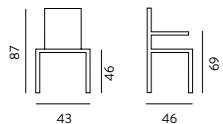

Art. 056 Brera

■ IMBALLO N. 4 pz.
Imballo speciale 1/3 pz. + 10,00 netto

■ **NORMALMENTE IN PRONTA CONSEGNA**

■ STRUTTURA POLIPROPILENE:

bianco - tortora - nero - senape - verde - ottanio

COD. 00138

INDOOR / OUTDOOR



NB: sui colori scuri sono presenti i segni dello stampaggio
il colore nero per uso outdoor va tenuto in zone ombreggiate



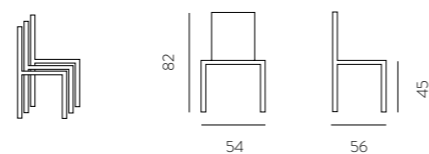

Art. 08 Pilar

- **IMBALLO N. 4 pz.**
Imballo speciale 1/3 pz. + 10,00 netto
- **NORMALMENTE IN PRONTA CONSEGNA**

- **POLIPROPILENE: bianco - sabbia - antracite** COD. 00126
NB: nel colore antracite sono presenti i leggeri segni dello stampaggio

INDOOR / OUTDOOR





Art. 043 Aurea

L57-P55-HS48-HT77

struttura polipropilene **nero**
 scocca polipropilene vari colori
 accessorio cuscinetto velluto o ecopelle

COD. 00136

COD. 0048

ORDINE MIN. 20 PZ.

■ **IMBALLO N. 4 pz. monocolore**
TEMPI 20/30 GG.



**SNOWBALL
EM**



**BLACK
NR**



**POWDER
ST**



**SWAMP
SC**



**MOSS
SD**



**CREAM
E7**



INDOOR / OUTDOOR



L'UNICA SEDIA IN POLIPROPILENE
CON SCHIENALE ALTO

mod. *Mirò*

■ IMBALLO N. 4 pz.

■ TEMPI CIRCA 40 GG. - ORDINE MIN. 48 PZ.

■ STRUTTURA POLIPROPILENE

bianco - sabbia - antracite - nera

COD. 00128

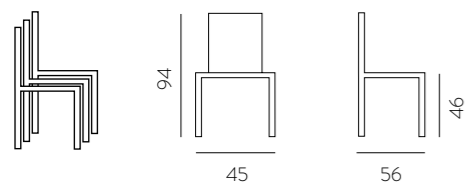



Base non disponibile vedi Art. 1779 Croce



INDOOR / OUTDOOR



Art. 042 Cab

■ **IMBALLO N. 4 pz.**
Imballo speciale 1/3 pz. + 10,00 netto

■ **NORMALMENTE IN PRONTA CONSEGNA**

■ **POLIPROPILENE:**
bianco - grigio - nero - ottanio COD. 00118

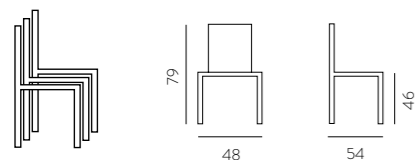

VERSIONE 100% RECYCLED certificata

Art. 042/G Cab Green

■ **POLIPROPILENE RICICLATO**
COLORI: light blu - antracite - grigio

COD. 00127



light blue



antracite



grigio

- **NB: ORDINE MINIMO 20 PZ.** (ANCHE COLORI ASSORTITI)
- **IMBALLO N. 4 pz. MONOCOLORE TAX**
- **TEMPI 20/30 GG**

NB: il polipropilene riciclato potrebbe avere delle leggere alonature dovute alla natura stessa del materiale



STEP 1
POLIMERI
DI PROVENIENZA
POST INDUSTRIALE



STEP 2
POLIMERI
DI PROVENIENZA
POST CONSUMO



STEP 3
RACCOLTA E
TRASPORTO
POLIMERI



STEP 4
TRASFORMAZIONE
IN NUOVO POLIMERO
CON RINFORZO
DI FIBRA DI VETRO



STEP 5
PRODOTTI IN
MATERIALE
ECOLOGICO



Art. 045 Falena Velvet

- PILE N. 22 pz.
apertura pila +10,00 netto
- **NORMALMENTE IN PRONTA CONSEGNA**
- **POLIPROPILENE OPACO: bianco - tortora chiaro** COD. 00118

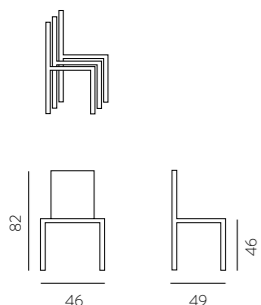

NEWS NERO OPACO

Sedia Art. 069 Route 66

- **IMBALLO N. 4 pz.** COD. 00108
- Imballo speciale 1/3 pz. + 10,00 netto

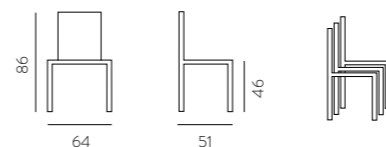

NON ADATTA PER USO OUTDOOR

Route 66 Stool

- **IMBALLO N. 4 pz.**
Imballo speciale 1/3 pz. + 10,00 netto
- **Art. 590/6 H65** COD. 00108
- **Art. 590/7 H74** COD. 00108

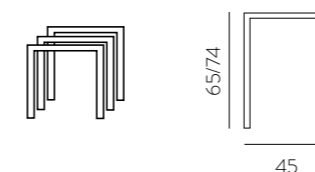

INDUSTRIAL





Sgabello 590



Sgabello 592

Sgabello 590

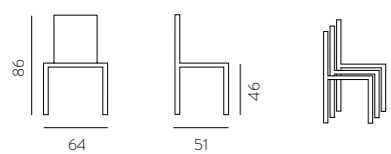

Art. 069 Route 66

- **IMBALLO N. 4 pz.**
Imballo speciale 1/3 pz. + 10,00 netto
- **NORMALMENTE IN PRONTA CONSEGNA**
- **STRUTTURA METALLO:** COD. 00136
- **NATURALE PROTETTO DA VERNICE TRASPARENTE**
- **COUNTRY CHIC (BIANCO ANTICATO)**
- **BRUNITO**

NON ADATTA PER USO OUTDOOR





Modello CUBA

- **NORMALMENTE IN PRONTA CONSEGNA**
- **STRUTTURA METALLO** verniciata **NERA**

▪ **SEDIA Art. 085** RATTAN POLIPROPILENICO: **nero - naturale**
 IMBALLO: FILE DA 33 PZ. - **APERTURA FILA € 10 NETTI**

COD. 00108

- **SGABELLO H65 Art. 585/6** RATTAN POLIPROPILENICO: **nero - naturale**
- **SGABELLO H75 Art. 585/7** RATTAN POLIPROPILENICO: **nero - naturale**
 IMBALLO: FILE DA 30 PZ. - **APERTURA FILA € 10 NETTI**

COD. 00153

COD. 00158

INDOOR / OUTDOOR

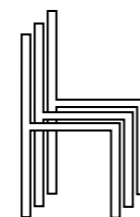



Art. 214 Dublin

■ **IMBALLO N. 2 pz.**
Imballo speciale 1 pz. + 10,00 netto

■ **NORMALMENTE IN PRONTA CONSEGNA**

■ **GAMBE**
METALLO VERNICIATO nero

■ **SEDILE ECOPELLE**
cuoio vissuto cognac

COD. 00218

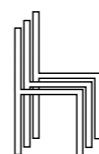
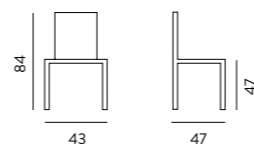
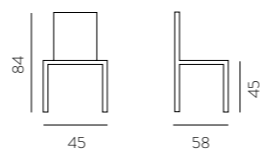

Art. 563
Italian Graffiti Stool
NB: H65 COD. 00178

Sgabello pag. 203



Art. 063 Italian Graffiti

■ **IMBALLO N. 5 pz.**
Imballo speciale 1/4 pz. + 10,00 netto

■ **NORMALMENTE IN PRONTA CONSEGNA**

■ **STRUTTURA METALLO VERNICIATO nero (TUBO Ø 25 MM)**

- LAMINATO NERO PLACCATO SU MULTISTRATI COD. 0098



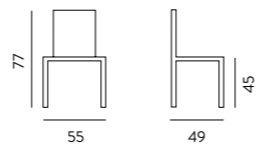

Mod. Budapest

ORDINE MINIMO 24 PZ - TEMPI 40/50 GG.

- **STRUTTURA SALDATA TIG**
VERNICIATA NATURALE O ALTRI COLORI A RICHIESTA
- **SEDILE / SCHIENALE FAGGIO MASSELLO**
tinto noce anticato catenato
- **SEDILE ECOPELLE VINTAGE:**
cuoio - testa di moro - verde inglese

COD. 00268

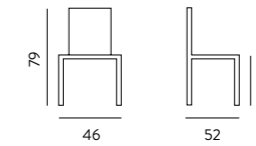

Mod. Praga

ORDINE MINIMO 24 PZ
TEMPI 40/50 GG.

- **STRUTTURA SALDATA TIG**
VERNICIATA NATURALE O ALTRI COLORI A RICHIESTA
- **SCHIENALE FAGGIO MASSELLO**
tinto noce anticato catenato
- **SEDILE ECOPELLE VINTAGE:**
cuoio - testa di moro - verde inglese

COD. 00206





verniciato: NERO o FERRO NATURALE
ecopelle VINTAGE cuciture a coste

TUBO Ø 25
PRODOTTO CEE - CUSTOMIZZABILE

Art. 066 Irish Chair

L43-P47-HS47-HT84 COD. 00198

Art. 566 Irish Stool

L43-P53-HS82-HT117 COD. 00276

ORDINE MINIMO 40 PZ - TEMPI 40/50 GG.



raso



Oro

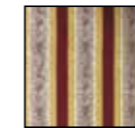

Bordeaux

velluto



Beige

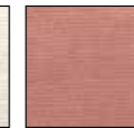

Rosa



Bordeaux

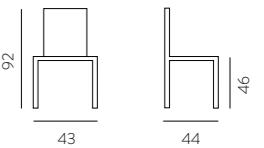

Art. 153 Vecchio Veneto

■ **IMBALLO N. 2 pz.**
Imballo speciale 1 pz. + 10,00 netto

■ **NORMALMENTE IN PRONTA CONSEGNA**

SEDILI:	VERA PAGLIA	MASSELLO	VELLUTO - GOBELIN	RASO
STRUTTURA:	NOCE SCURO	NOCE SCURO	NOCE SCURO	NOCE SCURO
	COD. 00104	COD. 00118	COD. 00128	COD. 00138

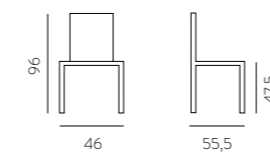

Art. 149 Castellana

■ **IMBALLO N. 2 pz.**
Imballo speciale 1 pz. + 10,00 netto
■ **NORMALMENTE IN PRONTA CONSEGNA**

■ **STRUTTURA:** NOCE SCURO
■ **SEDILI MASSELLO** COD. 00129





Art. 133 Paesana

- **IMBALLO N. 2 pz.**
Imballo speciale 1 pz. + 10,00 netto
- **NORMALMENTE IN PRONTA CONSEGNA**
- **SEDILI:**
- **STRUTTURA**
NOCE CHIARO-NOCE SCURO
LACCATO BIANCO ANTICATO
GREZZO

PAGLIA DI RISO

COD. 0076
eliminato
COD. 0069

MASSELLO

COD. 0088
COD. 00119
COD. 0076

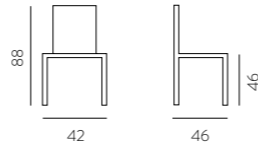

Art. 583/7 Paesana sgab. H72

- **IMBALLO N. 2 pz.**
- **NORMALMENTE IN PRONTA CONSEGNA**
- NOCE SCURO/PAGLIA DI RISO COD. 00154
- NOCE SCURO/MASSELLO COD. 00164

tavolo Art. 1010 Classic

- **ORDINE MINIMO 10 PZ. - TEMPI 20/30 GG.**
- struttura massello tinta noce
- piano nobilitato 20 mm (indicato per uso tovaglia)
- 80x80 COD. 00196
- solo struttura per piano 80x80 COD. 00179
- Prolunga nobilitato 80x80 COD. 00108
- Prolunga nobilitato 120x80 COD. 00108

Tavolo tradizionale predisposto di fori per prolunga
A richiesta con un minimo di quantità,
anche altre misure e varie tinte



Art. 1010/P - Prolunga per tavoli completa di ferri

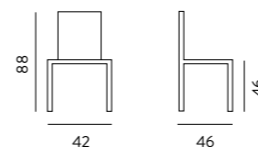

Art. 058 Nature

- **IMBALLO N. 2 pz.**
- **NORMALMENTE IN PRONTA CONSEGNA**
- **STRUTTURA**
FAGGIO/SEDILE PAGLIA DI RISO
FAGGIO TINTO ANILINA:
perla-arancio-verde-acquamarina
- COD. 0086





Art. 1010 **Classic all wood**

LACCATO BIANCO **COUNTRY CHIC**

ordine min. 12 pz (anche assortiti)

- 140x80 - H76

COD. 00498

- 120x80 - H76

COD. 00479

- 80x80 - H76

COD. 00398

- 80x80 - **H110** gamba quadra

COD. 00586

TEMPI 40/50 GG.

sgabello Art. 583/7 **Paesana**

LACCATO BIANCO **COUNTRY CHIC** / SEDILE MASSELLO

ordine min. 12 pz

COD. 00188

sedia Art. 133 **Paesana**

LACCATO BIANCO **COUNTRY CHIC** / SEDILE MASSELLO

NORMALMENTE IN PRONTA CONSEGNA

COD. 00119



Art. 086 *Attica*

- STRUTTURA FAGGIO:
NATURALE - NOCE CHIARO
NOCE MEDIO - CILIEGIO - WENGÈ

- **ORDINE MINIMO 20 PZ.**
TEMPI CIRCA 40 GG.

- SEDILE MASSELLO **COD. 0179**
- SEDILE ECOPELLE **COD. 0179**
supplemento struttura laccata + € 18,00



Art. 134 *Italia*

- STRUTTURA FAGGIO:
NATURALE - NOCE CHIARO
NOCE MEDIO - CILIEGIO
TINTE AL CAMPIONE + € 5,00 NETTI

- ECOPELLE COLORI A SCELTA

- **ORDINE MINIMO 40 PZ.**
TEMPI CIRCA 40 GG.

- **COD. 0096**

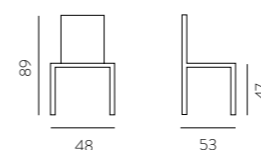

Art. 084 Croisette

■ PILE N. 10 pz.
apertura pila + 10,00 netto

■ **NORMALMENTE IN PRONTA CONSEGNA**

■ **STRUTTURA FAGGIO EUROPEO**

■ TINTO NATURALE / CANNA INTRECCIATA

COD. 00158

■ TINTO NOCE / ECOPELLE BROWN

COD. 00158

■ **NEWS - disponibili da agosto 2024**

ANILINA NERA / ECOPELLE NERA

COD. 00168

NOCE - CROCE METALLO NERA / ECOPELLE NERA

COD. 00168

Tinta noce / Sedile ecopelle custom
+ 28,00 €



impilabile 10 pz.



Art. 084 Croisette

■ PILE N. 10 pz.
apertura pila +10,00 netto

■ **NORMALMENTE IN PRONTA CONSEGNA**

■ **STRUTTURA FAGGIO EUROPEO**

■ TINTO NATURALE / CANNA INTRECCIATA

■ TINTO NOCE / ECOPELLE BROWN

■ **NEWS**
ANILINA NERA / ECOPELLE NERA
NOCE - CROCE METALLO NERA / ECOPELLE NERA

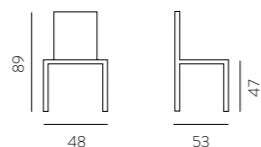

COD. 00158

COD. 00158

COD. 00168

COD. 00168



impilabile 10 pz.



STOOLS

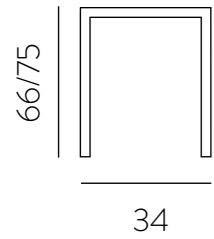

Tommy Stool

- **IMBALLO N. 4 pz.**
Imballo speciale 1/3 pz. + 10,00 netto
- **NORMALMENTE IN PRONTA CONSEGNA**
- **POLIPROPILENE RINFORZATO CON FIBERGLASS:**
bianco - nero - sabbia
- **ART. 526/6 H65** COD. 00114
- **ART. 526/7 H75** COD. 00118



INDOOR / OUTDOOR



Bitter Stool

- **TEMPI 20/30 GG**
- **STRUTTURA METALLO VERNICIATA nero**
- **SEDILE CUSTOM: VELLUTO O ECOPELLE**
- **ART. 532/7 H77** COD. 00158
- **ART. 532/6 H67** COD. 00158

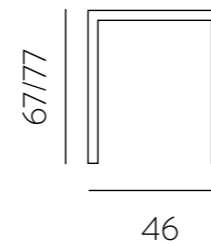

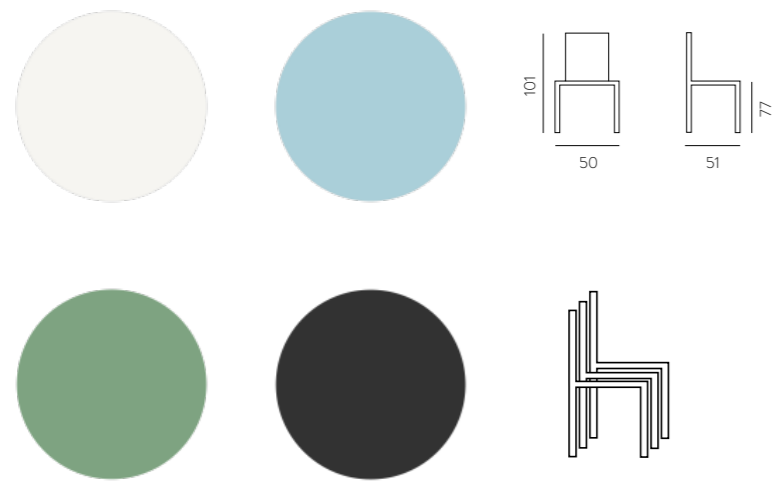

Art. 521/7 **Nike Stool** COD. 00118

- IMBALLO N. 2 pz. per colore TAX
- **NORMALMENTE IN PRONTA CONSEGNA**
- POLIPROPILENE: bianco - celeste - verde
- POLIPROPILENE RICICLATO nero

Art. 520/7 **Snake Stool** COD. 0096

- IMBALLO N. 2/4 pz.
- **NORMALMENTE IN PRONTA CONSEGNA**
DISPONIBILE DA MARZO 2025
- POLIPROPILENE: bianco - nero - sabbia

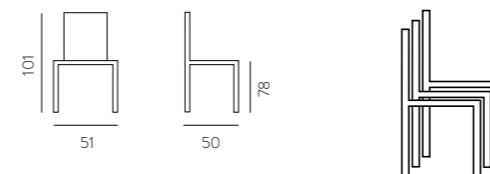



Joy Stool

- **IMBALLO N. 4 pz.**
- **Art. 564/6** H 65 COD. 00169
- **Art. 564/7** H 75 COD. 00178

STRUTTURA **NERA**

SEDILE/SCHIENALE polipropilene colorato:
ottanio - verde - mattone - nero - tortora

■ **DISPONIBILI DA FEBBRAIO 2025**

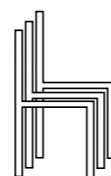
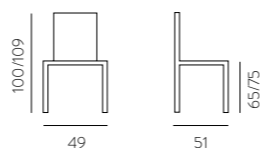

Ink Stool

- **IMBALLO N. 2 pz.**
Imballo speciale 1 pz. +10,00 netto
- **NORMALMENTE IN PRONTA CONSEGNA**
- **STRUTTURA POLICARBONATO TRASPARENTE**
- **Art. 544/6** H 65 COD. 00259
- **Art. 544/7** H 74 COD. 00259

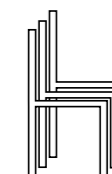
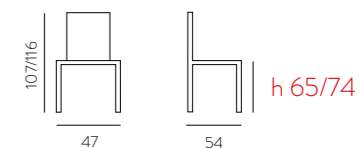



Gli sgabelli presenti nelle foto sono solo decorativi

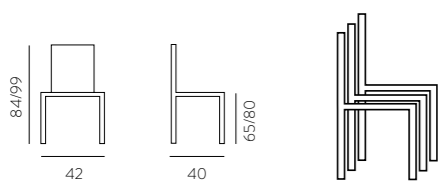

Art. 557/6 Prisma h 65

- **IMBALLO N. 4 pz.**
Imballo speciale 1/3 pz. + 10,00 netto
- **NORMALMENTE IN PRONTA CONSEGNA**

STRUTTURA:	CROMATO	BIANCA	TITANIO
■ SEDILI			
ECOPELLE: bianco	COD. 00259	COD. 00259	-
ECOPELLE: nero	COD. 00259	-	-
ECOPELLE: titanio	-	-	COD. 00259
ECOPELLE SPECIAL (TEMPI 30 GG)	COD. 00339	COD. 00339	COD. 00339
STOFFA CLIENTE 1 MT (TEMPI 30 GG)	COD. 00329	COD. 00329	COD. 00329

Art. 557/8 Prisma h 80

- **IMBALLO N. 4 pz.**
Imballo speciale 1/3 pz. + 10,00 netto
- **NORMALMENTE IN PRONTA CONSEGNA**

STRUTTURA:	CROMATO	BIANCA	TITANIO
■ SEDILI			
ECOPELLE: bianco - nero			COD. 00268
ECOPELLE SPECIAL (TEMPI 30 GG)			COD. 00348
STOFFA CLIENTE 1 MT (TEMPI 30 GG)			COD. 00338

Art. 1068 bancone **Cameo Break**

- **TEMPI 30 GG**
- **H 105** spessore piani 25 mm

STRUTTURA	P60	P80
L 120	COD. 00380	COD. 00410
L 140	COD. 00395	COD. 00430
L 160	COD. 00420	COD. 00460
L 180	COD. 00440	COD. 00490

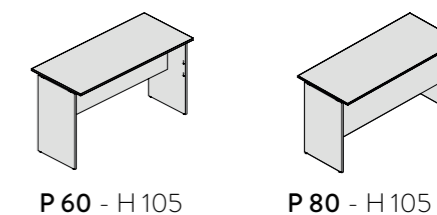



Brooke Stool

DANUBIO COLLECTION

H 65 Art. 571/6

H 75 Art. 571/7 + € 10,00

**NORMALMENTE IN PRONTA CONSEGNA
NO MINIMO ORDINE**

VELLUTO DAVIS : COD. 00338
tortora chiaro 16 - antracite 95
ECOPELLE LION: COD. 00338
cuoio 305 - titanio 020

VERSIONE CUSTOM NB: ordine minimo 12 pz.

VELLUTO COD. 00348
ECOPELLE COD. 00348
BOUCLÈ COD. 00358
TEMPI 50/60 GG.

GAMBE **ROVERE MASSELLO** TINTE:
noce canaletto - rovere - anilina nera

POGGIAPIEDI
IN METALLO NERO



GAMBE
ROVERE MASSELLO TINTE:
noce canaletto
rovere
anilina nera

L50 - P54 - HS65/75 - HT93/103



Art. 506/8 Lulù Stool H75 COD. 00208

Art. 506/6 Lulù Stool H65 COD. 00196

■ **NORMALMENTE IN PRONTA CONSEGNA**

■ **IMBALLO N. 2 pz.**
Imballo speciale 1 pz. + 10,00 netto

■ **STRUTTURA VERNICIATA NERA**
gamba Ø 22 conificata L53-P52-**HS75**-HT110

velluto:
antracite - grigio perla - verde bosco
rosa cipria - tortora - ottanio - mattone

cucitura con PIPING

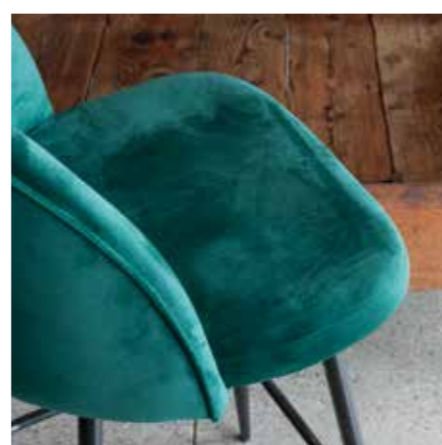

CUSTOM

stoffa cliente COD. 00258
mt. 1,2 cad.

tessuto cat. B COD. 00290
ECOPELLE - VELLUTO
TEMPI 40 GG.



cucitura con PIPING

OPERA STOOL

■ **STRUTTURA METALLO VERNICIATA NERO**
CON PUNTALI OTTONE GALVANICO

■ **VELLUTO: sabbia - grigio fumo**

■ **ART. 568/6 H65** COD. 00268

■ **ART. 568/7 H75** COD. 00278

■ **NORMALMENTE IN PRONTA CONSEGNA**

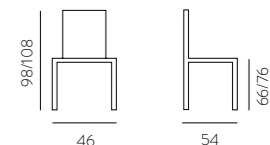

VERSIONE CUSTOM - 40 GG

H65
■ VELLUTO A CAMPIONARIO COD. 00382
■ STOFFA CLIENTE (1,5 MT) COD. 00348

H75
■ VELLUTO A CAMPIONARIO COD. 00392
■ STOFFA CLIENTE (1,5 MT) COD. 00358



Art. 517/8 **Ginger Stool** H 80

VELLUTO:
grigio fumo - tortora - senape - arancio - blu - verde

- STRUTTURA NERA/VELLUTO NON IGNIFUGO
- **NORMALMENTE IN PRONTA CONSEGNA**
- STRUTTURA OTTONE/VELLUTO NON IGNIFUGO
- (ordine minimo 10 PZ) **TEMPI 40/50 GG** con acconto

COD. 00269

COD. 00359

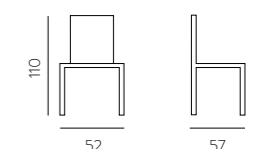

Velluto ignifugo + € 35,00 (ordine min. 10 pz.)

DISPONIBILE ANCHE H 65



accessorio piedino ottone H 8 cm
+ € 36,00 set 4 pz.



Norway Stool

- **IMBALLO N. 4 pz.**
Imballo speciale 1/3 pz. + 10,00 netto

- **NORMALMENTE IN PRONTA CONSEGNA**
- STRUTTURA METALLO VERNICIATA **nero**
- SEDILE RETRO SCHIENALE LISCIO

- **SEDILE**
ECOPELLE EFFETTO NABUK: beige - grigio

ECOPELLE UNICOLOR:
titanio - tortora fango - ghiaccio (tortora chiaro) - nera

- ART. **510/2** BASE 4 GAMBE H65 COD. 00276

- ART. **510/3** BASE 4 GAMBE H80 COD. 00289

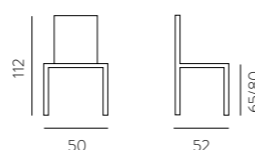



DISPONIBILE ANCHE H 65

Art. 582/8 **Juliette Stool H 80**

struttura verniciata: **NERO** / velluto antimacchia

COD. 00296

NORMALMENTE IN PRONTA CONSEGNA

velluto: grigio fumo - celeste - rosa - verde - ottanio - mattone - giallo

Velluto ignifugo + € 35,00 (ordine min. 10 pz.)

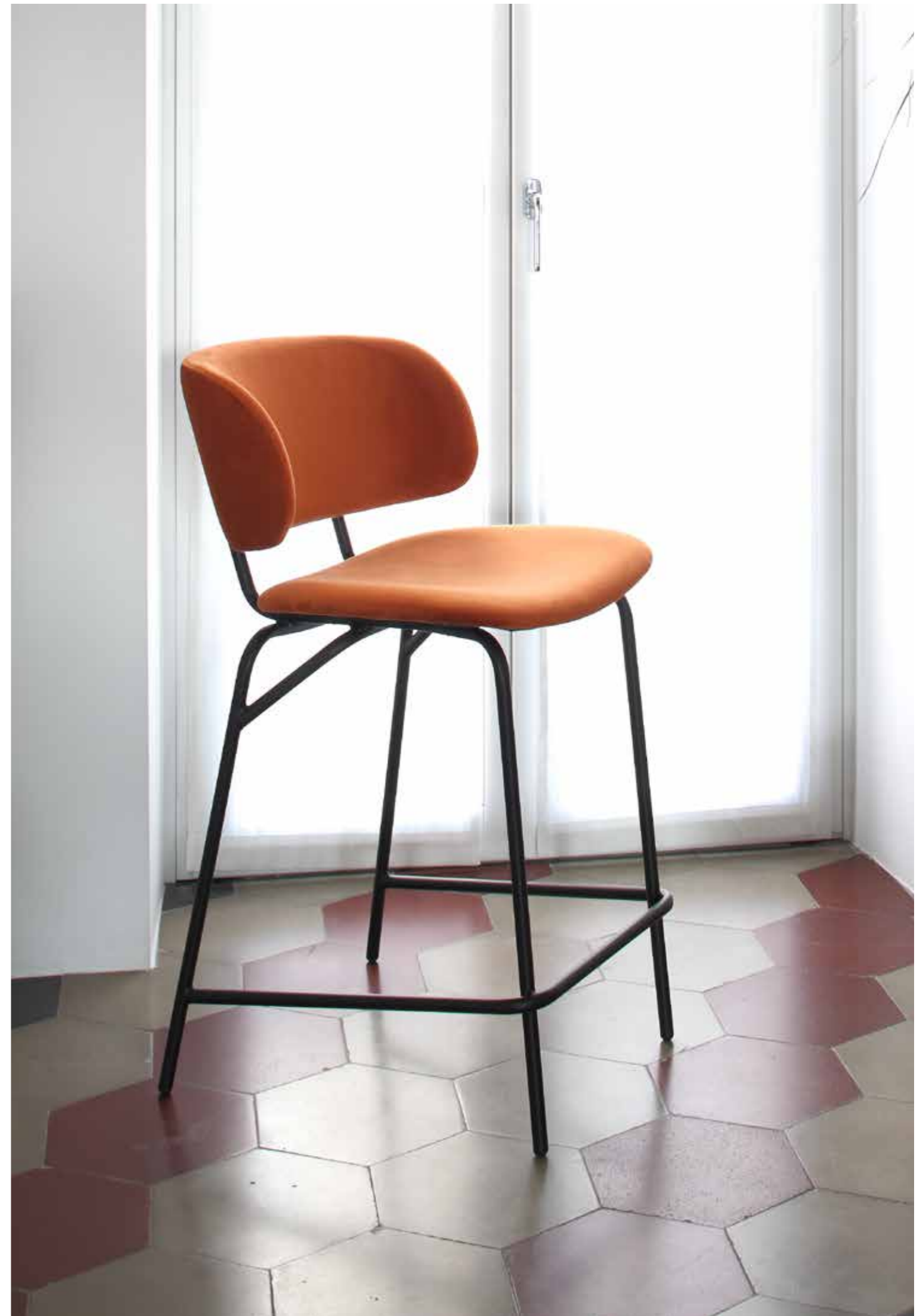
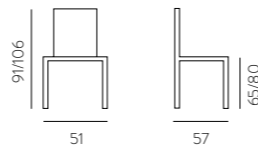

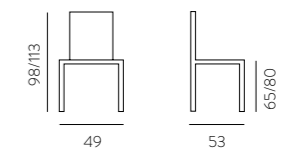

Cinquecento Stool

- **IMBALLO N. 4 pz.**
Imballo speciale 1/3 pz. + 10,00 netto
- **NORMALMENTE IN PRONTA CONSEGNA**
- **STRUTTURA METALLO VERNICIATA nero**
- **SEDILE**
ECOPELLE EFFETTO NABUK:
beige - grigio
- **ART. 500/1** BASE SLITTA **H65** COD. 00249
- **ART. 500/2** BASE 4 GAMBE **H65** COD. 00276
- **ART. 500/3** BASE 4 GAMBE **H80** COD. 00289

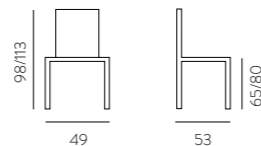

Dublin Stool

- **IMBALLO N. 4 pz.**
Imballo speciale 1/3 pz. + 10,00 netto
- **NORMALMENTE IN PRONTA CONSEGNA**
- **STRUTTURA METALLO VERNICIATA nero**
- **SEDILE: ECOPELLE cuoio vissuto cognac**
- **ART. 514/1** BASE SLITTA **H65** COD. 00249
- **ART. 514/2** BASE 4 GAMBE **H65** COD. 00276
- **ART. 514/3** BASE 4 GAMBE **H80** COD. 00289

disponibile solo con
ecopelle di serie





Hollywood Stool

- IMBALLO N. 1 pz.
- **NORMALMENTE IN PRONTA CONSEGNA**

■ STRUTTURA: CROMATO

■ SEDILI

- ECOPELLE GRAFFITI:

arancio - blu - verde - giallo - rosso

- SPRINT (BANDA BIANCA): **TEMPI 30 GG.**

arancio - blu - verde - giallo - rosso - nero
bianco/banda nera

- ITALY FLAG 

■ SEDIA Art. 049

ECOPELLE GRAFFITI

- SPRINT (BANDA BIANCA): **TEMPI 30 GG.**

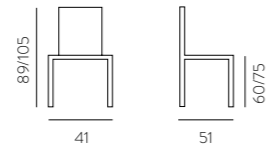

Art. 535/6 H60

Art. 535/7 H75

COD. 00286

COD. 00306

COD. 00307

COD. 00327

COD. 00307

COD. 00327

COD. 00218

COD. 00239



INDOOR / OUTDOOR

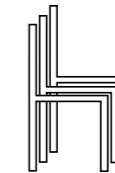

Modello CUBA Stool

- **NORMALMENTE IN PRONTA CONSEGNA**

DISPONIBILE DA AGOSTO 2024

- STRUTTURA METALLO verniciata **NERA**

- SGABELLO H65 Art. 585/6 RATTAN POLIPROPILENICO: **nero - naturale**

COD. 00153

- SGABELLO H75 Art. 585/7 RATTAN POLIPROPILENICO: **nero - naturale**

COD. 00158

IMBALLO: FILE DA 30 PZ. - **APERTURA FILA € 10 NETTI**





Route 66 Stool

■ **NORMALMENTE IN PRONTA CONSEGNA**

■ **IMBALLO N. 4 pz.**
Imballo speciale 1/3 pz. + 10,00 netto

- **Art. 590/6 H65:**
 - COUNTRY CHIC (BIANCO ANTICATO) COD. 00128
 - BRUNITO COD. 00128
 - NATURALE PROTETTO DA VERNICE TRASPARENTE COD. 00128
 - NERO OPACO COD. 00108
- **Art. 590/7 H74:**
 - COUNTRY CHIC (BIANCO ANTICATO) COD. 00134
 - BRUNITO COD. 00134
 - NATURALE PROTETTO DA VERNICE TRASPARENTE COD. 00134
 - NERO OPACO COD. 00108

Route 66 Back Stool

■ **IMBALLO N. 4 pz.**
Imballo speciale 1/3 pz. + 10,00 netto

- **Art. 592/6 H65:**
 - COUNTRY CHIC (BIANCO ANTICATO) COD. 0133
 - BRUNITO COD. 0133
- **Art. 592/7 H74:**
 - COUNTRY CHIC (BIANCO ANTICATO) COD. 0139

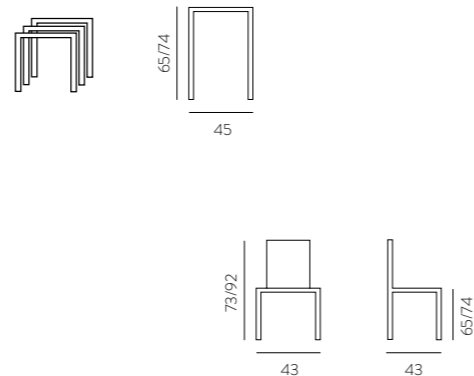

Giotto

- **IMBALLO N. 1 pz.**
- **NORMALMENTE IN PRONTA CONSEGNA**
- **STRUTTURA FAGGIO NATURALE**
PARTICOLARI POLIPROPILENE **nero**
- **Art. 508/4** DA H 42 A 55 COD. 00158
- **Art. 508/6** DA H 67 A 80 COD. 00189

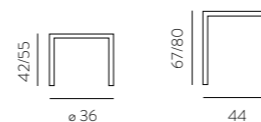

Art. 580 Urban

- **IMBALLO N. 1 pz.**
- **NORMALMENTE IN PRONTA CONSEGNA**
- **STRUTTURA METALLO**
VERNICIATA NERO INDUSTRIAL
- **SEDILO LEGNO NOCE INDUSTRIAL** COD. 00186

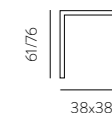



Art. 584 Jordan

■ **IMBALLO N. 2 pz.**
Imballo speciale 1 pz. + 10,00 netto

■ **NORMALMENTE IN PRONTA CONSEGNA**

■ **STRUTTURA:** NERA

■ **SEDILI**
POLIPROPILENE NERO / ECOPELLE nero COD. 00136

POLIPROPILENE NERO / VELLUTO CUSTOM: COD. 00168
ottanio - verde - giallo - mattone - grigio fumo - tortora

RICAMBI: guarnizione sottobase (tipo grande) COD. 0019 - pistone COD. 0036

■ **USO DOMESTICO, NON GARANTITO PER LOCALE PUBBLICO**

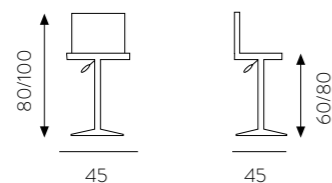

TOP QUALITY

Art. 575 Maxim

■ **IMBALLO N. 1 pz.**

■ **NORMALMENTE IN PRONTA CONSEGNA**

■ **STRUTTURA:** CROMATO

■ **SEDILE SCHIUMATO**
ECOPELLE: bianco - nero - titanio COD. 00436

ECOPELLE SPECIAL (TEMPI 30 GG) COD. 00536

ECOPELLE CLIENTE: 1 mt (TEMPI 30 GG) COD. 00508

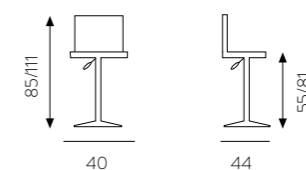



Art. 574 Jazz

ECOPELLE:
bianco - nero - tortora chiaro COD. 00188

NORMALMENTE IN PRONTA CONSEGNA

**NB:
NON CONSIGLIATI E GARANTITI PER USO INTENSIVO**

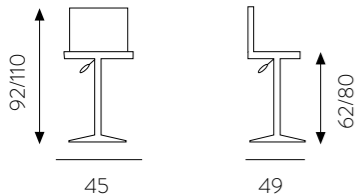

Art. 550 Fruit

■ POLIPROPILENE/ECOPELLE:
bianco-arancio-rosso-verde-nero-grigio chiaro COD. 00136

NORMALMENTE IN PRONTA CONSEGNA

**NB:
NON CONSIGLIATI E GARANTITI PER USO INTENSIVO**

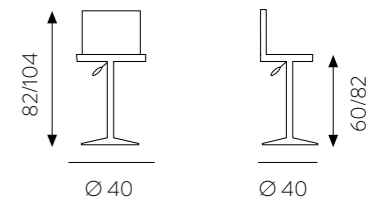



Art. 481/G **Gancio a muro**
(max 6 pezzi)
L.40 - P. 21
COD. 0064



Art. 481/CA **Carrello**
(max 8 pezzi)
38x50xh.119
COD. 00128



Art. **463 Bit lux** aperta: L45-P51-HS43-HT77 - chiusa: 91x3

■ STRUTTURA CROMATA / POLIPROPILENE TRASLUCIDO COD. 0089

■ IMBALLO N. 4 pz.

Art. **462 Bit**

■ STRUTTURA VERNICIATA IN TINTA / POLIPROPILENE: COD. 0068
bianco - nero - brown



Art. **481/CA Carrello**
38x50xh119 COD. 00128



Art. **481/G Gancio**
L 40 - P 21 COD. 0064

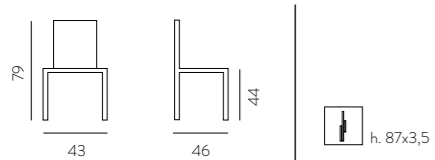

Art. **465 Steel**

■ IMBALLO N. 6 pz.
Imballo speciale 1/5 pz. +10,00 netto

■ **NORMALMENTE IN PRONTA CONSEGNA**

■ STRUTTURA
POLIPROPILENE: nero - bianco traslucido

ALLUMINIO

COD. 0063

TORTORA

-

POLIPROPILENE: **tortora chiaro**

-

COD. 0063



NORMALMENTE IN PRONTA CONSEGNA



Art. 468 Dreen

■ POLIPROPILENE:

bianco - antracite - sabbia - verde

COD. 00106

DESIGN E ROBUSTEZZA
ADATTA ANCHE PER
OUTDOOR

aperta: L48 - P52 - HS45 - HT82
chiusa: 94x11

NORMALMENTE IN PRONTA CONSEGNA

INDOOR / OUTDOOR



Art. 481/CA Carrello
38x50xh119 COD. 00128

Art. 481/G Gancio
L 40 - P 21 COD. 0064





Art. 436 Fellini

L56-P54-HS45-HT85
chiuso/close L18-P54-H85

148,00	SOLO STRUTTURA FAGGIO TINTO: NATURALE-NOCE-MOGANO-ANILINA NERA NB: AGGIUNGERE COSTO COPPIE TELE
--------	--------------------------------------------------------------------------------------------------------------

168,00	VERSIONE PLUS SOLO STRUTTURA NB: AGGIUNGERE COSTO COPPIE TELE
--------	-------------------------------------------------------------------------

435/3	COPPIE TELE NORMALI PER CIAK-FELLINI	29,00	TELA COTONE ECRÙ TELA ACRILICA : NATURALE-BIANCO OTTICO NERO-CAFFÈ-ROSSO-BORDEAUX VERDE BOTTIGLIA-BLU
435/4	COPPIE TELE TRAPUNTATE PER CIAK-FELLINI	56,00	TELA COTONE ECRÙ TELA ACRILICA : NATURALE-BIANCO OTTICO NERO-CAFFÈ-ROSSO-BORDEAUX VERDE BOTTIGLIA-BLU
435/5	COPPIE TELE PVC RETINO PER CIAK-FELLINI per outdoor	44,00	BIANCO OTTICO-BIANCO CREMA-NERO ROSSO-BORDEAUX-BLU-GIALLO

PRODOTTO CEE
ordine min 20 pz.
anche assortiti

INDOOR / OUTDOOR
DEHOR COPERTO



Art. 435/1 Ciak Chair

L59-P44-HS45-HB69-HT89
chiuso/close L17-P44-H113

168,00	SOLO STRUTTURA FAGGIO TINTO: NATURALE-NOCE-MOGANO-ANILINA NERA NB: AGGIUNGERE COSTO COPPIE TELE
--------	--------------------------------------------------------------------------------------------------------------

Art. 435/2 Ciak Stool

L59-P50-**HS65/75**-HB89/99-HT109/119
chiuso/close L17-P50-H127/137

196,00	SOLO STRUTTURA HS. 65 / 75 FAGGIO TINTO: NATURALE-NOCE-MOGANO-ANILINA NERA NB: AGGIUNGERE COSTO COPPIE TELE
--------	--------------------------------------------------------------------------------------------------------------------------





OUTDOOR



Pergola Bioclimatica 3x4 mt

STRUTTURA ALLUMINIO VERNICIATA ANTRACITE **TOP QUALITY**
teito lamellare chiudibile / orientabile - NB. meccanismo a manovella integrato
sistema di raccolta acqua con scarico integrato all'interno dei montanti

Pergola **Art. 1850/1**

accessorio

Kit tende oscuranti e zanzariere **Art. 1850/2**

COD. 002390

COD. 00456

NORMALMENTE IN PRONTA CONSEGNA

(fino ad esaurimento scorte stagionali)

DISPONIBILE DA FEBBRAIO 2025

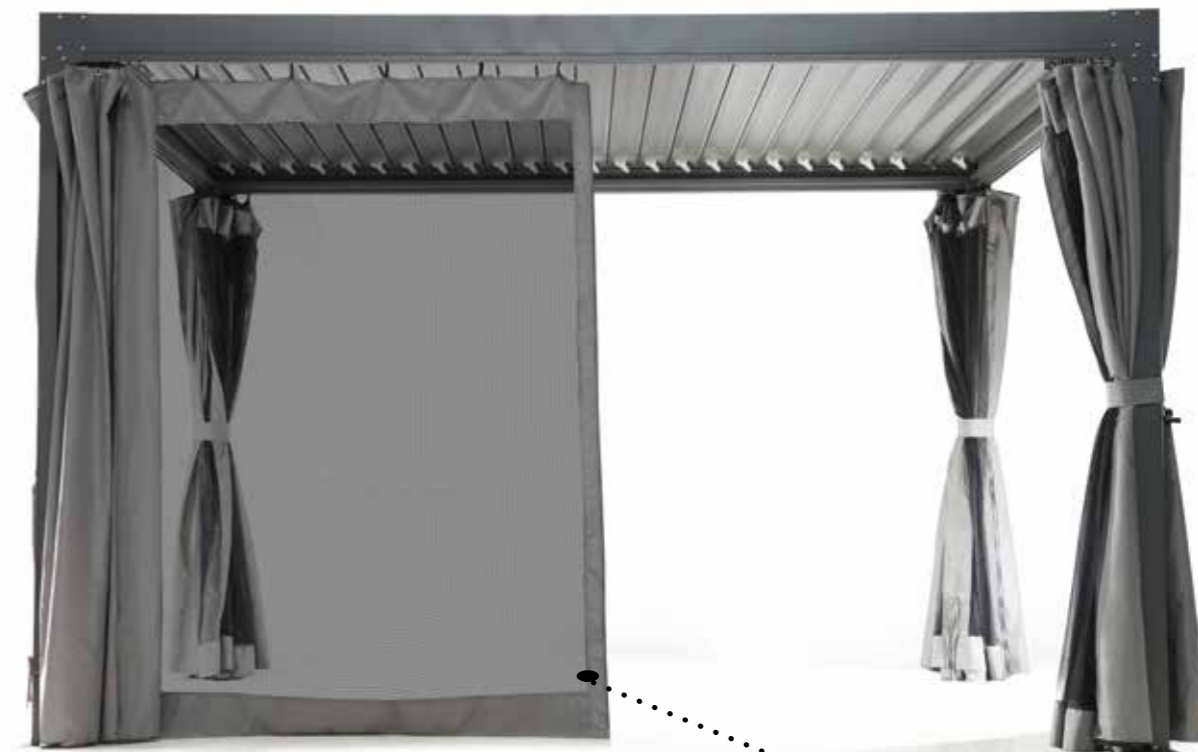



BASI
per **OUTDOOR**



Basi **TROLL**

ALLUMINIO
(con zavorra e piedini regolabili)
verniciata **NERO**



fissa h73 Art. 1740/1
fissa h109 Art.1740/2

COD. 00127
COD. 00139

chiudibile bassa h73 Art. 1750/1
chiudibile alta h108 Art. 1750/2

COD. 00147
COD. 00159

NORMALMENTE IN PRONTA CONSEGNA



MECCANISMO CHIUSURA TOP QUALITY

NB: aggiungere piano, vedi HPL

adatte per zone marine
spiagge, ecc.

Mosaico basi per esterno USO DEHOR

non adatte per ambienti estremamente umidi, zone saline, spiagge (vedi base mod. Rimini)



Art. 1032 Piatta nera Art. 1032 Piatta bianca Art. 1031 Piramide Art. 1046 Como Art. 1052 Impero Art. 1043 Bistrot



Base Art. 1053 Spritz COD. 00108

NORMALMENTE IN PRONTA CONSEGNA

metallo verniciato **nero**

per piani max 60x60 - Ø60
uso bar/gelateria

NO ristorazione

BASI
per **OUTDOOR**



BASE mod. RIMINI ALLUMINIO PER ZONE SALINE O ALTO TASSO DI UMIDITÀ



Base in ghisa verniciata (zavorra), con cover **alluminio**
Tubo 8x8 in **alluminio** verniciato

H 72 Art. 1760 COD. 00139
40x40-H72 verniciata nera
per piani max 90x90

H 108 Art. 1762 COD. 00169
40x40-H72 verniciata nera
per piani max 70x70

NORMALMENTE IN PRONTA CONSEGNA

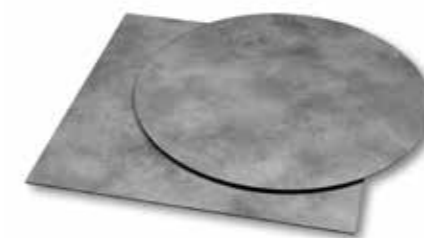

spessore 10 mm

Piani **HPL** vedi pag. 18-20

PIANI per OUTDOOR

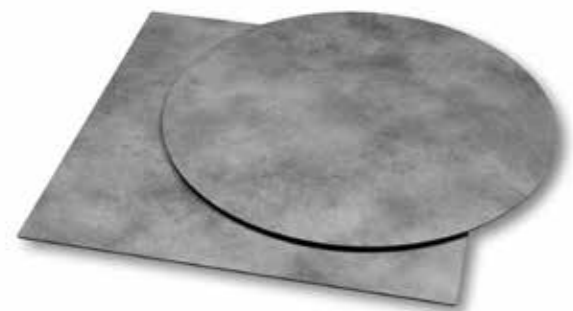

spessore 10 mm

Piani **HPL** vedi pag. 18-20



Art. 1100TE Piano Teak

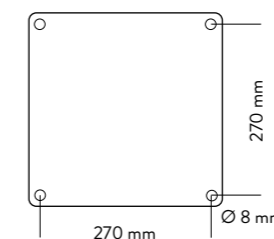

predisposto per basi con piastre G02 (interasse 270 mm.)



NORMALMENTE IN PRONTA CONSEGNA

Fino ad esaurimento scorte stagionali.

Teak massello (vero teak indonesiano)

70 x 70	COD. 00178
80 x 80	COD. 00196
Ø 70	COD. 00169

Optional applicazione bussole antistrappo (con vite brugola)

+ € 8,00 netti consigliabile solo per basi in ghisa

piani MONTECARLO

Listelli resina effetto wood, tinta teak - spessore 18 mm

NB: NO MANUTENZIONE fine stagione

Sotto struttura metallo con trattamento elettroforesi antiruggine, verniciata polvere doppio passaggio

TOP 70x70 Art. 1204
TOP 80x80 Art. 1204

COD. 00176
COD. 00198

NORMALMENTE IN PRONTA CONSEGNA

TAVOLI per **OUTDOOR**



accatastabile



Sedia *Aster Rope*



Poltroncina Art. 1126 *Atlantica*

Art. 1808 *Metal Quadro*

tavolo accatastabile per outdoor
AUTOLIVELLANTE

Tavolo metallo 4 gambe saldate con trattamento per esterno verniciato: **BIANCO - ANTRACITE - NERO**

NORMALMENTE IN PRONTA CONSEGNA

NELLE MISURE:

70x70	COD. 00330 - nb: ORDINE BANCALE (N. 20) PER MISURA E COLORE	COD. 00228
80x80	COD. 00345 - nb: ORDINE BANCALE (N. 20) PER MISURA E COLORE	COD. 00239



Art. 070 Parigi

■ **IMBALLO PILE N. 24 pz. monocolore**
 apertura imballo + 10,00 netto

■ **NORMALMENTE IN PRONTA CONSEGNA**

■ **RESINA RINFORZATA CON FIBERGLASS:**
 bianco - nero - sabbia COD. 00108

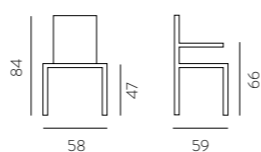

TOP QUALITY

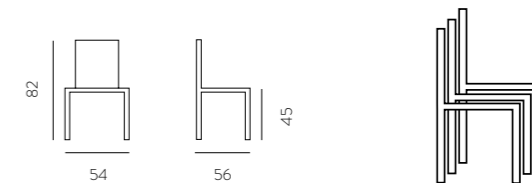

Art. 08 Pilar

- IMBALLO N. 4 pz.
- **NORMALMENTE IN PRONTA CONSEGNA**

■ POLIPROPILENE: COD. 00126
bianco - sabbia - antracite

NB: nel colore antracite sono presenti i leggeri segni dello stampaggio





1126 Atlantica COD. 00156

L57-P62-HS44-HT90

- PILE N. 24 pz. - apertura pila +10,00 netto
- **NORMALMENTE IN PRONTA CONSEGNA**
- STRUTTURA POLIPROPILENE:
bianca / retina textilene bianca
tortora / retina textilene tortora
antracite / retina textilene nera

con retina top quality

Serge Ferrari
group

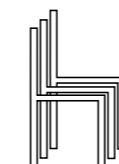



1126 Atlantica

COD. 00156

L57-P62-HS44-HT90

- PILE N. 24 pz. - apertura pila +10,00 netto
- **NORMALMENTE IN PRONTA CONSEGNA**
- STRUTTURA POLIPROPILENE:
bianca / retina textilene bianca
tortora / retina textilene tortora
antracite / retina textilene nera

con retina top quality

Serge Ferrari
group

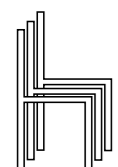
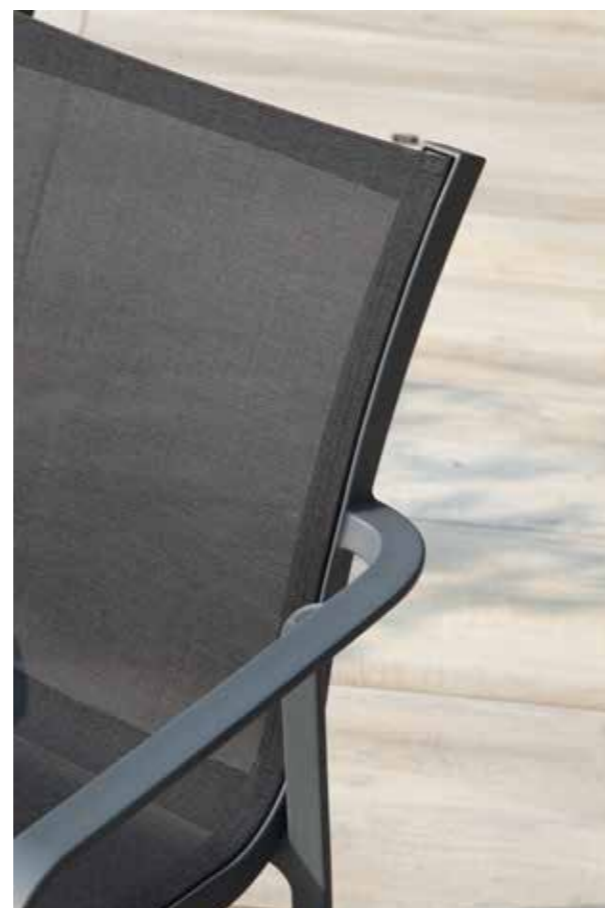

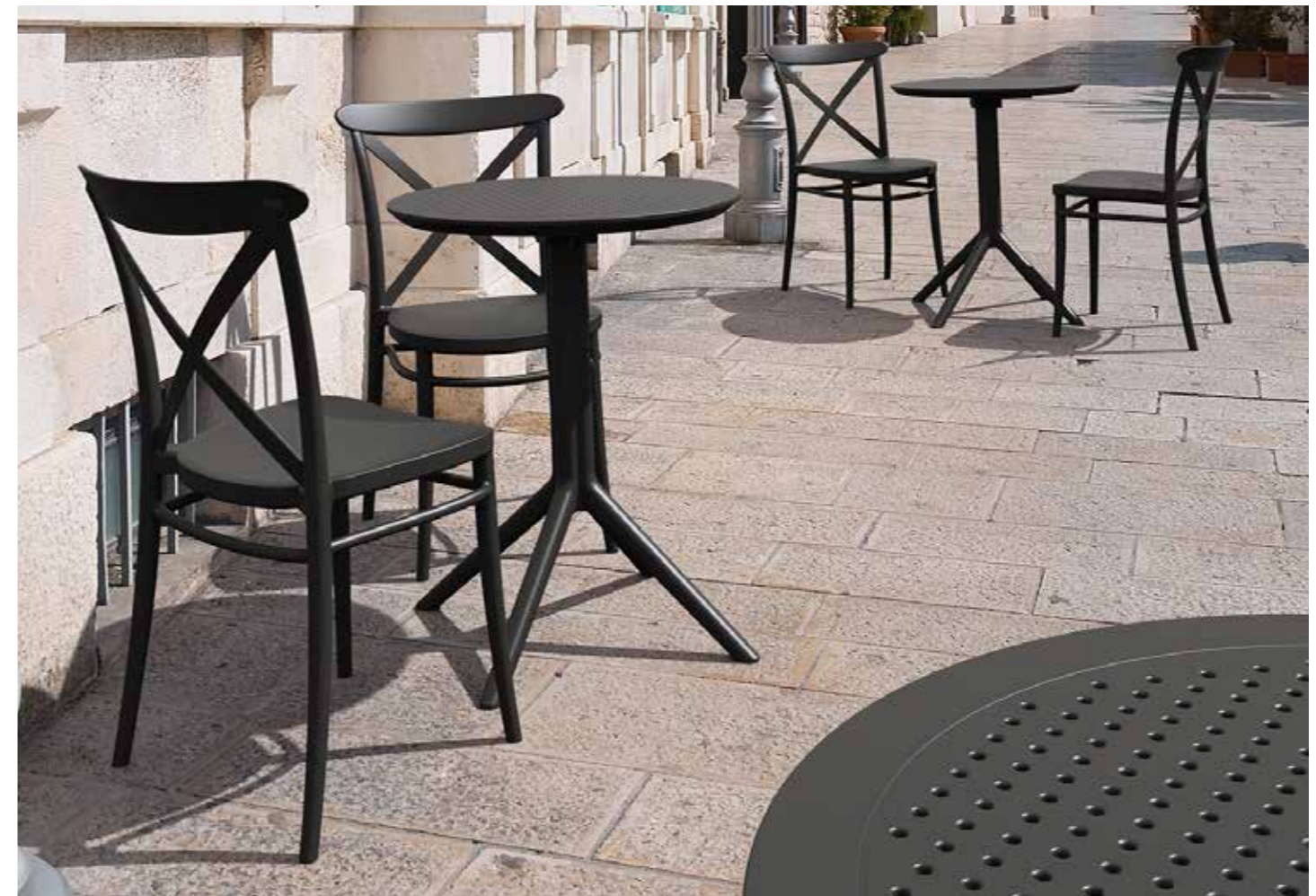

Art. 078 Borgo Antico

- **IMBALLO PILE N. 14 pz. monocolore**
apertura imballo + 10,00 netto
- **NORMALMENTE IN PRONTA CONSEGNA**
- **RESINA RINFORZATA CON FIBERGLASS:**
bianco - sabbia - nero COD. 0099

TOP QUALITY

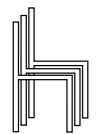

impilabile

IL BANQUETING



Art. 074 **CHIAVARINA**

■ POLIPROPILENE **bianco**

COD. 0059

DISPONIBILE DA MARZO 2025

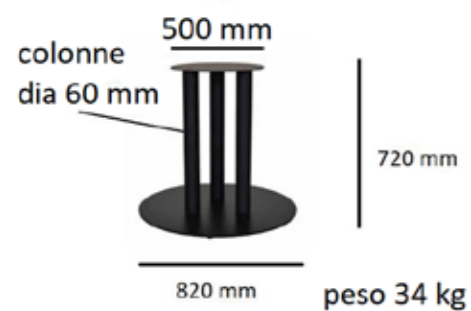

Art. 1035 **Big Round**

verniciata nera
per piani max Ø180

COD. 00290



Base non disponibile vedi Art. 1779 Croce

Art. 043 **Aurea**

L57-P55-HS48-HT77

struttura polipropilene **nero** COD. 00136
scocca polipropilene vari colori

accessorio cuscinetto COD. 0048
velluto o ecopelle

■ **IMBALLO N. 4 pz. monocolori**
TEMPI 30 GG.
NB: ordine min 20 pz. con acconto





bracciolini in vero teak



Art. 1848 Playa

Sedia regista **alluminio** chiudibile
verniciatura per esterno **nera** COD. 00148
bracciolini in vero teak

NORMALMENTE IN PRONTA CONSEGNA
(fino ad esaurimento scorte stagionali)
DISPONIBILE DA MARZO 2025



Art. 1846 Calypso

Poltroncina **alluminio** impilabile
verniciatura per esterno **nera** COD. 00138
Retina textilene **antracite**

NORMALMENTE IN PRONTA CONSEGNA
(fino ad esaurimento scorte stagionali)
DISPONIBILE DA MARZO 2025



VENICE

design Edi e Paolo Ciani

Telaio in **alluminio** verniciato **poliestere**
Schienale seduta rivestito in corda sintetica
TOP QUALITY intrecciata a mano



Colori: **verde - antracite**
bianco/intreccio grigio chiaro

Sedia **Art. 1830/1** COD. 00248

L56-P59-HS46 - HT80

Imballo a pile da 12 - apertura pila € 10,00 netti

Sgabello **Art. 1830/2** COD. 00297

L55-P53-HS76 - HT104

Imballo a pile da 13 - apertura pila € 10,00 netti

NORMALMENTE IN PRONTA CONSEGNA
(fino ad esaurimento scorte stagionali)

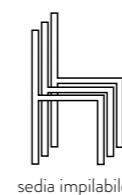



BASE mod. **RIMINI** ALLUMINIO
PER ZONE SALINE O ALTO TASSO DI UMIDITÀ
con piano Art. 1051 HPL

SIVIGLIA

Telaio in **alluminio** verniciato **poliestere**
Schienale seduta rivestito in corda sintetica
TOP QUALITY intrecciata a mano

Colori: **terracotta - antracite - bianco**/intreccio grigio chiaro

Sedia Art. **1830/3** COD. 00358

L59-P63-HS47 - HT81

Imballo 4 pz. - imballo speciale 1/3 € 10,00 netti

Sgabello Art. **1830/5** COD. 00396

L43-P59-HS73 - HT102

Imballo 4 pz. - imballo speciale 1/3 € 10,00 netti

design Edi e Paolo Ciani

NORMALMENTE IN PRONTA CONSEGNA
(fino ad esaurimento scorte stagionali)

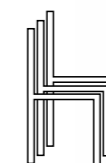



linea MONTECARLO

Struttura metallo Ø 19 mm con trattamento elettroforesi antiruggine, verniciata polvere doppio passaggio

Sedile e schienale resina effetto wood, tinta teak spessore 18 mm - **NB: NO MANUTENZIONE fine stagione**

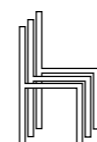

SEDIA Art. 1200

COD. 00186

POLTRONCINA Art. 1202

COD. 00198

TOP 70x70 Art. 1204

COD. 00176

TOP 80x80 Art. 1204

COD. 00198

predisposto per basi con piastre G02 (interasse 270 mm.)





Art. 1814/1 **Aster Metal**

Sedia metallo impilabile
verniciatura e trattamento per esterno
verniciata **nera** COD. 00118

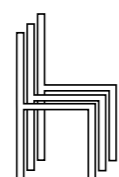

NORMALMENTE IN PRONTA CONSEGNA



Art. 1816/1 **Aster Rope**

Sedia metallo impilabile
verniciatura e trattamento per esterno
verniciata **nera** COD. 00198
intreccio di corda a mano antracite



Modello **CUBA**

■ **NORMALMENTE IN PRONTA CONSEGNA**

■ **STRUTTURA METALLO** verniciata **NERA**

■ **SEDIA Art. 085** RATTAN POLIPROPILENICO: **nero - naturale**
IMBALLO: FILE DA 33 PZ. - **APERTURA FILA € 10 NETTI**

■ **SGABELLO H65 Art. 585/6** RATTAN POLIPROPILENICO: **nero - naturale**

■ **SGABELLO H75 Art. 585/7** RATTAN POLIPROPILENICO: **nero - naturale**
IMBALLO: FILE DA 30 PZ. - **APERTURA FILA € 10 NETTI**



COD. 00108

COD. 00153

COD. 00158



Poltroncina impilabile

Art. 1832 **Panarea** COD. 00168

Intreccio di corda:
marsala - tortora - antracite

struttura metallo verniciata per esterni **in tinta**

pile da 13 pz.

NORMALMENTE IN PRONTA CONSEGNA
(fino ad esaurimento scorte stagionali)
DISPONIBILE DA GENNAIO 2025

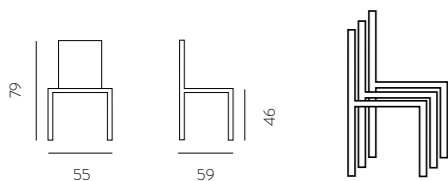



mod Café de Paris

intreccio corda piatta **tortora**
struttura metallo zincato **antracite**

NORMALMENTE IN PRONTA CONSEGNA
(fino ad esaurimento scorte stagionali)

Poltroncina impilabile
Art. 1823/15

L60-P55-H79
scatole da 4

COD. 00256

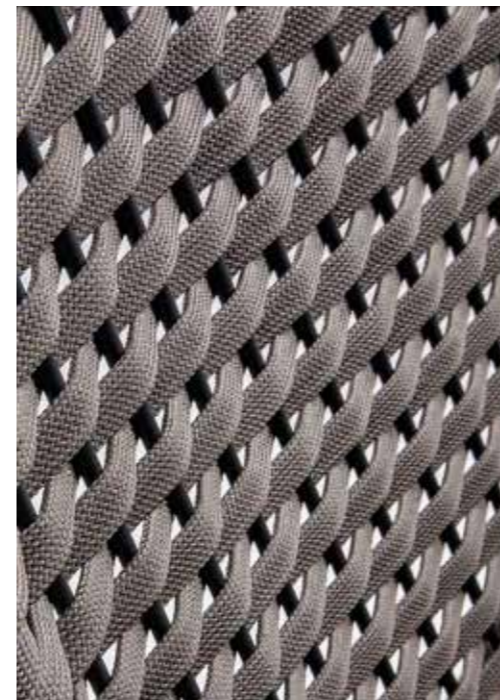
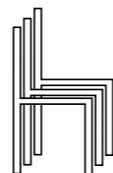

Sgabello impilabile
Art. 1823/17

L58-P50-HS75-HT98 COD. 00296



Poltroncina impilabile
Art. 1823/14 Biarritz

treccia poliestere (interno gomma) **antracite**
struttura metallo zincato **antracite**

L57-P56-H81 COD. 00296
scatole da 4

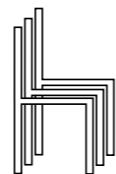

NORMALMENTE IN PRONTA CONSEGNA
(fino ad esaurimento scorte stagionali)



base foto non disponibile, vedi Art. 1053 Spritz





Art. 1823/40 Poltroncina Taormina

intreccio corda poliestere
cuscineria gomma idrofuga / tessuto acrilico **GRIGIO**
struttura alluminio verniciata **BIANCA**

COD. 00360

L57-P59-HS45-H76
pile da 12 pz., IMBALLO speciale 1/6 € 10,00 netti

NORMALMENTE IN PRONTA CONSEGNA
(fino ad esaurimento scorte stagionali)

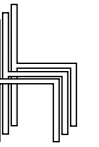



Art. 1823/2 Nice Stool COD. 00394

L53-P49-HS75-HT98

- struttura ANTRACITE / intreccio BROWN
- struttura NERA / intreccio ANTRACITE

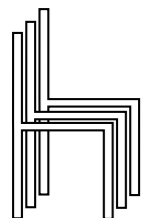

Art. 1823/1 Poltroncina Nice black

L57-P63-HS45-H76

COD. 00379

intreccio corda poliestere interno gomma
cuscineria gomma idrofuga / tessuto acrilico ANTRACITE
struttura alluminio verniciata NERA

pile da 10 pz., IMBALLO speciale 1/6 €10,00 netti

NORMALMENTE IN PRONTA CONSEGNA

(fino ad esaurimento scorte stagionali)





Art. 1823/1 **Poltroncina Nice brown**

L57-P63-HS45-H76

COD. 00379

intreccio corda poliestere interno gomma
 cuscineria gomma idrofuga / tessuto acrilico **BROWN**
 struttura alluminio verniciata **ANTRACITE**

pile da 10 pz., IMBALLO speciale 1/6 € 10,00 netti

NORMALMENTE IN PRONTA CONSEGNA

(fino ad esaurimento scorte stagionali)



Art. 1823/2 **Nice Stool**

COD. 00394





Poltrona
Art. 1823/3 NICE POLTRONA
 L80-P79-HT70
 COD. 00970
 Imballo 2 pz.
 Imballo singolo + € 20,00 netti

Divano 3 posti (2 cuscini)
Art. 1823/4 NICE DIVANO
 L165-P79-HT70
 COD. 001780

Tavolino rettangolare
Art. 1823/5 NICE TAVOLINO
 L110-P60-H42
 COD. 00340

Nice Sofà

intreccio corda poliestere interno gomma
 cuscineria gomma idrofuga / tessuto acrilico **BROWN**
 struttura alluminio verniciata **ANTRACITE**

NORMALMENTE IN PRONTA CONSEGNA
 (fino ad esaurimento scorte stagionali)



Tavolino
Art. 1823/20 Corinto Antracite
 verniciato antracite
 70x56-H37 COD. 00270
 100x70-H34 COD. 00360





Divano 3 posti (2 cuscini) COD. 001780

Art. 1823/30 SOLARIS DIVANO

L165-P79-HT70

Poltrona COD. 00970

Art. 1823/31 SOLARIS POLTRONA

L80-P79-HT70

Tavolino

Art. 1823/32 Corinto Black

verniciato nero

55x45-H40

COD. 00190

70x56-H37

COD. 00270

100x70-H34

COD. 00360



Solaris Sofà

intreccio corda poliestere interno gomma

cuscineria gomma idrofuga / tessuto acrilico **ANTRACITE**

struttura alluminio verniciata **NERA**

NORMALMENTE IN PRONTA CONSEGNA

(fino ad esaurimento scorte stagionali)





Art. 1840 Set **Maui** antracite vedi pagina dopo

bracciolini in vero teak



bracciolini in vero teak

Art. 1840 Set **Maui** bianco

SET COMPLETO COD. 002390

composto da:
divano + 2 poltrone + tavolino

Struttura alluminio verniciata:
BIANCO - ANTRACITE

Cuscini stoffa per esterni GRIGIA
Bracciolini vero teak

NORMALMENTE IN PRONTA CONSEGNA
(fino ad esaurimento scorte stagionali)
DISPONIBILE DA MARZO 2025



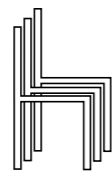

Poltrona
 Art. 1823/41
 L80-P79-HT75
 COD. 00890

Tavolino
 Art. 1823/20 **Corinto White**
 100x70-H34 COD. 00360

Divano 3 posti (2 cuscini)
 Art. 1823/42
 L160-P79-HT75
 COD. 001380

Poltroncina da tavolo
 Art. 1823/40
 L57-P59-HS45-H76
COD. 00360
 pile da 12

Serie Taormina

intreccio corda poliestere
 cuscineria gomma idrofuga / tessuto acrilico **GRIGIO**
 struttura alluminio verniciata **BIANCA**

NORMALMENTE IN PRONTA CONSEGNA
 (fino ad esaurimento scorte stagionali)



Serie Taormina Marsala

intreccio corda poliestere
cuscineria gomma idrofuga / tessuto acrilico
struttura alluminio verniciata

NORMALMENTE IN PRONTA CONSEGNA
(fino ad esaurimento scorte stagionali)
DISPONIBILE DA MARZO 2025

Poltrona
Art. 1823/51
L80-P79-HT75 COD. 00890

Divano 3 posti (2 cuscini)
Art. 1823/52
L160-P79-HT75 COD. 001380

Tavolino
Art. 1823/53 **Corinto Marsala**
100x70-H34 COD. 00360





Set OLYMPUS

SOLO SET COMPLETO COMPOSTO DA:
SOFÀ 2 / 3 POSTI + 2 POLTRONE + 1 TAVOLINO

ANTRACITE / CUSCINI GRIGI

NORMALMENTE IN PRONTA CONSEGNA

(fino ad esaurimento scorte stagionali)

set sofà 2 posti COD. 004090

Art. 1822/2 Set Olympus 2 posti

DIVANO L137-P80-H71
POLTRONA L76-P80-H71
TAVOLINO L90-P55-H36

set sofà 3 posti COD. 004480

Art. 1822/3 Set Olympus 3 posti

DIVANO L178-P80-H71
POLTRONA L76-P80-H71
TAVOLINO L90-P55-H36



Cobb

Base / seduta tessuto per esterni GRIGIO
rete ANTRACITE - cuscinetti come foto
gomma idrofuga per esterni / struttura alluminio

NORMALMENTE IN PRONTA CONSEGNA
(fino ad esaurimento scorte stagionali)



Tavolino
Art. 1823/20 **Corinto Antracite**
verniciato antracite
70x56-H37 COD. 00270
100x70-H34 COD. 00360

Poltrona

Art. 1824/5 COBB POLTRONA COD. 001560
L103-P82-HT92-HS42

Divanetto

Art. 1824/6 COBB DIVANO COD. 002290
L158-P101-HT92-HS42

Tavolino Pouf

Art. 1824/8 COBB POUF COD. 00580
L98-P73-H42



Divanetto

Art. 1824/11 COUCH DIVANO

COD. 002080

L151-P83-HT72

Poltrona

Art. 1824/10 COUCH POLTRONA

COD. 001390

L86-P83-HT71

Tavolino

Art. 1824/13 COUCH TAVOLINO

COD. 00590

piano alluminio verniciato:

TORTORA intreccio tortora - **GRIGIO** intreccio antracite

L66-P66-H38



Couch

stoffa per esterni:

TORTORA intreccio tortora - **GRIGIO** intreccio antracite

gomma idrofuga per esterni / struttura alluminio

NORMALMENTE IN PRONTA CONSEGNA

(fino ad esaurimento scorte stagionali)



Lettino

Art. 1824/15 COUCH BED

L190-P82-H36

COD. 001690



Divanetto
 Art. 1824/11 COUCH DIVANO
 COD. 002080
 L151-P83-HT72

Poltrona
 Art. 1824/10 COUCH POLTRONA
 COD. 001390
 L86-P83-HT71

Tavolino
 Art. 1824/13 COUCH TAVOLINO
 COD. 00590
 piano alluminio verniciato:
TORTORA intreccio tortora - **GRIGIO** intreccio antracite
 L66-P66-H38



Couch

stoffa per esterni:
TORTORA intreccio tortora - **GRIGIO** intreccio antracite
 gomma idrofuga per esterni / struttura alluminio

NORMALMENTE IN PRONTA CONSEGNA
 (fino ad esaurimento scorte stagionali)



Tavolino
 Art. 1823/20 **Corinto Antracite**
 verniciato antracite
 70x56-H37 COD. 00270
 100x70-H34 COD. 00360



Couch Bed

stoffa per esterni:

TORTORA intreccio tortora - **GRIGIO** intreccio antracite
gomma idrofuga per esterni / struttura alluminio

NORMALMENTE IN PRONTA CONSEGNA

(fino ad esaurimento scorte stagionali)



Lettino

Art. 1824/**15** COUCH BED
L190-P82-H36

COD. 001690



Art. 1823/12 **Nice Bed**

L200 - P70 - H37/93 - schienale 4 posizioni
COD. 001390

intreccio corda poliestere interno gomma
cuscineria gomma idrofuga / tessuto acrilico **BROWN**
struttura alluminio verniciata **ANTRACITE**



NORMALMENTE IN PRONTA CONSEGNA
(fino ad esaurimento scorte stagionali)



Tavolino
Art. 1823/20 **Corinto Antracite**
verniciato antracite
70x56-H37 COD. 00270
100x70-H34 COD. 00360



Art. 1823/35 **Solaris Bed**

L200 - P70 - H37/93 - schienale 4 posizioni
COD. 001390

NORMALMENTE IN PRONTA CONSEGNA
(fino ad esaurimento scorte stagionali)

Tavolino
Art. 1823/32 **Corinto Black**
verniciato nero
55x45-H40 COD. 00190
70x56-H37 COD. 00270
100x70-H34 COD. 00360





Lettino Art. 1824/18 Plano COD. 001680

L203-P90-HS38-HT60 - - schienale 4 posizioni

STRUTTURA IN ALLUMINIO VERNICIATA **ANTRACITE**

CON GOMMA DRENANTE FAST DRY FOAM,
RIVESTIMENTO TESSUTO SUMBRELLA® **GRIGIO CIELO**

NORMALMENTE IN PRONTA CONSEGNA

(fino ad esaurimento scorte stagionali)



Tavolino

Art. 1823/20 **Corinto Antracite**

verniciato antracite

70x56-H37 COD. 00270

100x70-H34 COD. 00360





lettino OCEANO

PRODOTTO TOP QUALITY

Lettino impilabile Art. 1124 COD. 00358
 struttura polipropilene / textilene:
bianco - tortora - antracite/retina nera

Misure 68x193
 Schienale reclinabile 5 posizioni
 Piedini antiscivolo (parte anteriore) + **rotelline (parte posteriore)**

- BANCALE DA 18 pz.
 Apertura imballo 1/6 pz. + 20,00 netto
 Apertura imballo 7/17 pz. + 10,00 netto



Tavolino multiuso Art. 1125 COD. 0088
 struttura polipropilene:
bianco - tortora - antracite

Misure 45x45 H45 - IMBALLO 1 pz.

con retina top quality

Serge Ferrari
 group

NORMALMENTE IN PRONTA CONSEGNA





Art. 1797/6 Set **Portocervo**

POLIPROPILENE **BIANCO** / CUSCINERIA **TORTORA** COD. 001380

Composto da:
1 DIVANETTO - L128-P67-H80
2 POLTRONE - L67-P67-H80
1 TAVOLINO - L62-P62-H40

NORMALMENTE IN PRONTA CONSEGNA
(fino ad esaurimento scorte stagionali)



i cuscini e gli accessori usati per ambientazione, non disponibili

linea BUBBLE

TOP QUALITY
totalmente manifattura e materiali
MADE IN ITALY

Tutti i tessuti sono completamente sfoderabili e lavabili.
 Imbottitura interna in sfere di EPS
 racchiuse in una fodera interna di poliestere.

INDOOR / OUTDOOR



TEMPI 20/30 GG. - VEDI PAGINA DOPO





OTTANIO 32

CUSCINONE MULTIUSO Art. 1210/1
140x120 - H30 COD. 00460



LIME 305

POLTRONA Art. 1210/2
L80 - P95 - HS40 - HT80 COD. 00460



ZAFFERANO 104

CHAISE LOUNGE Art. 1210/3
L100 - P150 - HS35 - HT70 COD. 00350



GRIGIO TORTORA 233

POLTRONA SACCO Art. 1210/4
Ø90 - H120 COD. 00420



ANTRACITE 19

POUF TAVOLINO Art. 1210/5
80x80 - H35 COD. 00280



MELANGE BEIGE 110

POUF Art. 1210/6
40x40 - H35 COD. 00195

ESEMPIO DI COMPOSIZIONE DIVANO ANGOLARE

NB: LE POLTRONE SONO ACCOSTATE (NON AGGANCIATE)

POUF TAVOLINO Art. 1210/5	POL-TRONA Art. 1210/2	POL-TRONA Art. 1210/2	POL-TRONA Art. 1210/2
	POL-TRONA Art. 1210/2	POUF TAVOLINO Art. 1210/5	
POL-TRONA Art. 1210/2			



VINACCIA 09



MELANGE BLU 16



BIANCO LINO 218

LETTINO Art. 1210/7
L70 - P200 - H80 COD. 00890

campionando 4 pezzi
mazzetta tessuti
omaggio

tessuto INDOOR

COTONE RIGENERATO 100% GRS
Nessun utilizzo di prodotti chimici o tintoria
Riutilizzo delle materie prime come il cotone

9 COLORI

- OTTANIO 32
- LIME 305
- ZAFFERANO 104
- GRIGIO TORTORA 233
- ANTRACITE 19
- MELANGE BEIGE 110
- VINACCIA 09
- MELANGE BLU 16
- BIANCO LINO 218



i prodotti sono composti da
doppio sacco:
di stoffa estetico e
all'interno un sacco tecnico
contenente le sfere di EPS
ad alta densità

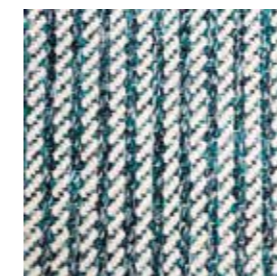

SPIGATO AZZURRO
dis.1539 col.01



SPIGATO BEIGE
dis.1539 col.07

tessuto OUTDOOR



tessuto TECNICO PP 100%



MELANGE BEIGE
dis.1537 col.08

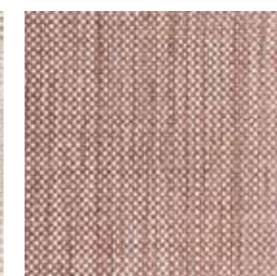

MELANGE ROSA
dis.1537 col.13

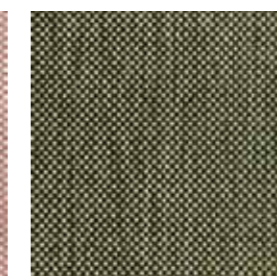

MELANGE VERDE
dis.1537 col.11



MELANGE AZZURRO
dis.1537 col.01



MELANGE BLU
dis.1537 col.02



Art. 1821/12 Real Table

- **VERO MASSELLO DI TEAK INDONESIANO**
CON FINITURA OLIO NATURALE
 - MISURE: Ø 150 (8 persone) - H 75 COD. 001880
 - MISURE: Ø 180 (10 persone) - H 75 COD. 002190
- portavivande girevole

Note: il teak è un'essenza tropicale giungendo in Europa con clima diverso tende a seccarsi, potrebbero comparire in superficie tracce bianche di resina secca. Per ravvivare e conservare l'immagine unica di questa essenza, basta trattarla con l'apposito olio per dare e conservare freschezza, lucentezza e protezione. Consigliabile inizio e fine stagione.



Art. 1820/1 Resort Chair

- STRUTTURA BANANO - L47 x P52 x HS51 x HT101
- SEDILE CUSCINO ecrù COD. 00228



Art. 1821/3 Folding Chair

cuscinetto ecrù idrorepellente
tax IMBALLO 2 pz.

COD. 00195 cad.



Art. 1820/9 Croco Sofà

- 1820/9 P poltrona L 84 x P 87 COD. 00790
- 1820/9 D2 divano 2p L 164 x P 87 COD. 001690
- 1820/9 D3 divano 3p L 195 x P 87 COD. 001990
- 1820/9 T tavolino 130 x 60 x H 35 COD. 00460

linea RESORT ETNICO

(INTRECCIO DI BANANO* NATURALE)

*non resistente agli agenti atmosferici,
specialmente alla pioggia

NORMALMENTE IN PRONTA CONSEGNA

(fino ad esaurimento scorte stagionali)

Art. 1820/5 Clito Mini Sofà

- 1820/5 P poltrona L 75 x P 78 COD. 00520
- 1820/5 D divanetto L 125 x P 78 COD. 00870
- 1820/5 T tavolino 85 x 45 x H 40 COD. 00290



OFFICE & COMUNITÀ

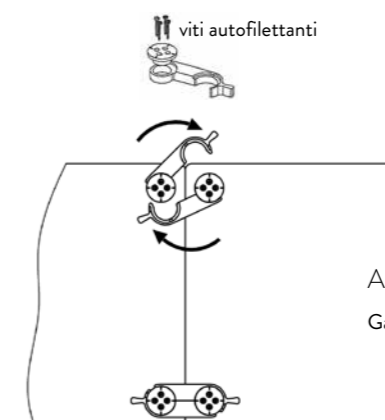

Accessorio Art. 1050 **GPR GANCI** COD. 0016 cad.
Gancio per prolunghe, con gancio si intende maschio / femmina

montaggio sui top non compreso



Art. 1065 **DUAL**

Ingombro terra gamba 76 - Polipropilene nero

solo base per piano: 150/200 x 80/ 90max

COD. 00550

TEMPI 20/30 GG.

solo piano nobilitato 20 mm

150x90: bianco COD. 00227 - colori speciali COD. 00296

180x90: bianco COD. 00279 - colori speciali COD. 00358

200x90: bianco COD. 00335 - colori speciali COD. 00429

■ COSTI GESTIONE TECNICA, ORDINI SOTTO:

5 PIANI + € 40,00 NETTI - 10 PIANI + € 30,00 NETTI - OLTRE 10 PIANI NESSUN SUPPLEMENTO



Sedie
pieghevoli
vedi pag. 240

NOTA TECNICA

azionando leva di chiusura,
con il ribaltamento del piano,
in automatico le gambe
divaricano,
permettendo di riporre i tavoli
in spazi contenuti (vedi foto)



Art. 1064/3
Fargo Round



PIANI NOBILITATO 19mm: BIANCO - GRIGIO - NERO
 diametro 160 COD. 00970
 diametro 180 COD. 00990
 ellittico 240x150 COD. 001240

SOLO STRUTTURA

verniciata nera COD. 003160
 cromata COD. 003680
 Tavolo completo sommare base piano



Art. 1064/2
Fargo Rectangular

SOLO STRUTTURA

per piano da 200 a 260 v. nera
 per piano da 200 a 260 cromata
 per piano da 280 a 320 v. nera
 per piano da 280 a 320 cromata

COD. 002730
 COD. 003145
 COD. 002960
 COD. 003430

PIANI NOBILITATO 19mm: BIANCO - GRIGIO - NERO

200 x 80/90/100 COD. 00670
 220 x 80/90/100 COD. 00770
 240 x 80/90/100 COD. 00860
 260 x 80/90/100 COD. 00960
 280 x 80/90/100 COD. 001060
 300 x 80/90/100 COD. 001160
 320 x 80/90/100 COD. 001280

Tavolo completo sommare base piano



Art. 1062 Omega

SOLO STRUTTURA piano cliente
 cromata COD. 00380
NORMALMENTE IN PRONTA CONSEGNA

PIANI NOBILITATO 19mm
 colori vedi Art. 1060 (pag. 25)
 160 x 80/90 COD. 00340
 180 x 80/90 COD. 00380
 200 x 80/90 COD. 00430
TEMPI 20/30 GG

misura a terra gamba 60 cm



Art. 1015 Kit Pratico

set 4 gambe nere COD. 00180
 set 4 gambe cromate COD. 00190
NORMALMENTE IN PRONTA CONSEGNA
 Per scelta piani Art. 1060



Piedino regolabile



Art. 673 Atene **Chrome**

■ **NORMALMENTE IN PRONTA CONSEGNA**

■ **STRUTTURA CROMATA/PIANI VETRO TEMPERATO 12 MM TRASPARENTE - H 77**

■ **VETRO TRASPARENTE**
temperato 12 mm - H 76

140x80

160x85

180x90

■ **CROMO**

COD. 00750

COD. 00770

COD. 00790

■ **SOLO BASE CROMO**
piano cliente

COD. 00475

COD. 00485

COD. 00495

sedia eliminata



Sedia 253/4G **Carnaby 4G**

Art. 673 Atene **Noir**

■ **NORMALMENTE IN PRONTA CONSEGNA**

■ **VETRO TRASPARENTE**
temperato 12 mm - H 76

140x80

160x85

180x90

■ **NERO**

COD. 00750

COD. 00770

COD. 00790

■ **SOLO BASE NERO**
piano cliente

COD. 00475

COD. 00485

COD. 00495



tavolino eliminato

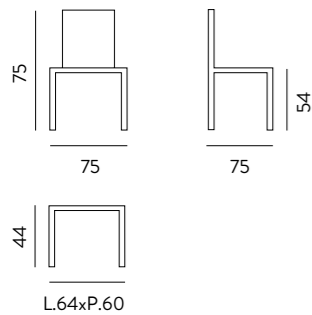

Art. 856 Ragni

- TEMPI 20 GG.
 - STRUTTURA TONDINO CROMATO
 - PIANO NOBILITATO:
- bianco - olmo - noce - cemento - tortora
- Ø46 - H48 COD. 00186
 Ø46 - H53 COD. 00186



Bikini

- IMBALLO N. 1 pz.
 - NORMALMENTE IN PRONTA CONSEGNA
 - STRUTTURA: CROMATA
 - SEDILI ECOPELLE:
- | | | | | |
|---------------------|--------|------------|------|------------|
| Art. 427/1 POLTRONA | bianco | COD. 00890 | nero | COD. 00890 |
| Art. 427/2 POUF | | COD. 00490 | | COD. 00490 |



Art. 864 Stylo

- IMBALLO N. 1 pz.
- NORMALMENTE IN PRONTA CONSEGNA
- POLIPROPILENE / ALLUMINIO NERO COD. 00136
- MISURE: Ø 47 x H 174

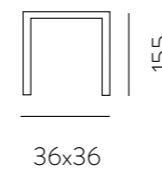

Art. 867 Dumbo

- IMBALLO N. 1 pz.
- NORMALMENTE IN PRONTA CONSEGNA
- COLONNA FAGGIO NATURALE CON BASE ZAVORRATA
- POLIPROPILENE: bianco - nero COD. 00128



Art. 982 Iso Chair

acripol ignifugo: **blu-rosso-nero** COD. 0089

NORMALMENTE IN PRONTA CONSEGNA

SU ORDINAZIONE 40 GG. con acconto
BRACCIOLINO CON TAVOLETTA + € 44,00
COPPIA BRACCIOLI + € 38,00

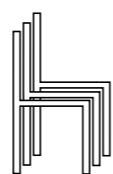

acripol



Rosso



Blu



Nero

Art. 982/P Iso-Panka

TEMPI 30 GG. - NO PROMO

- 2 MODULI L. 110-P. 62
- 3 MODULI L. 165-P. 62
- 4 MODULI L. 220-P. 62

acripol
ecopelle
COD. 00620
COD. 00810
COD. 00890

ATTESA CONFERENZA

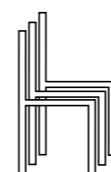

Art. 987 Meeting Chair

struttura **cromata/ABS ignifugo nero** COD. 0079
dotata di gancio saldato per allineamento file
NORMALMENTE IN PRONTA CONSEGNA

Gancio per file



Alina Panka

3 sedute Art. 986.2761 IG * L152
4 sedute Art. 986.2762 IG * L202
5 sedute Art. 986.2763 IG * L252

COD. 00780
COD. 00940
COD. 001090

CON TAVOLINO + sedute

2 sedute Art. 986.2771 IG * L152
3 sedute Art. 986.2772 IG * L202
4 sedute Art. 986.2773 IG * L252

COD. 00780
COD. 00940
COD. 001090

COLORI SEDUTE

panna soft - grigio chiaro - antracite

* **IGNIFUGHE** classe 1

P52 - H82 - HS46

TEMPI 30 GG. - NO PROMO





Sedia

Art. 986.2675
Art. 986.2675 IG *
 L51-P52-HS46-HT82
 imballo 4 pz. TAX

COD. 00136
 COD. 00192

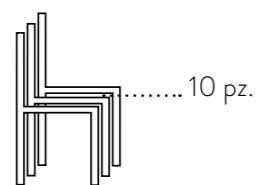

gancio
Art. 986.2941 COD. 0034
 imballo 10 pz. TAX

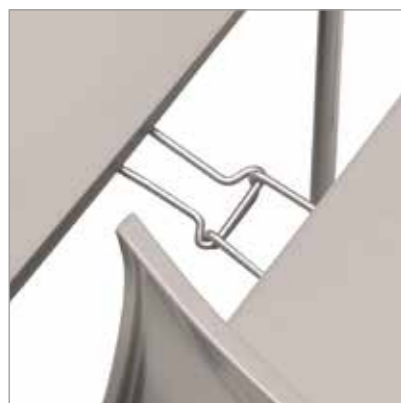

Accessorio tavoletta
antipanico con movimento a ribalta
Art. 986.2946
 COD. 00162
 imballo 2 pz. TAX



carrello
Art. 986.2944
 COD. 00215
 imballo 2 pz. TAX

maniglione
Art. 986.2948
 COD. 0060



Sedia 4 gambe 15pz.
Sedia con braccioli 15pz.
Sedia slitta 20pz.



Sedia con braccioli

Art. 986.2676
Art. 986.2676 IG *
 L53-P52-HS46-HT82
 H bracciolo 67
 imballo 2 pz. TAX

COD. 00202
 COD. 00258

Alina Conference

- struttura cromata
 polipropilene: bianco panna - antracite - grigio chiaro - tortora
- struttura antracite / polipropilene antracite

- * **IGNIFUGA** struttura cromata
 polipropilene: bianco panna - antracite - grigio chiaro



Sedia con base a slitta

base: cromata - verniciata antracite

Art. 986.2677
Art. 986.2677 IG *
 L53-P52-HS46-HT82
 imballo 2 pz. TAX

COD. 00179
 COD. 00232



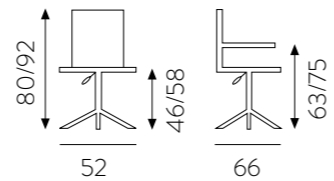

Art. 968 Twister

- **IMBALLO N. 4 pz.**
Imballo speciale 1/3 pz. + 10,00 netto
- **NORMALMENTE IN PRONTA CONSEGNA**
- **ALZO A GAS**
- **CUSCINO IN TINTA ECOPELLE**
- **STRUTTURA NERA** COD. 00188
- **SEDILI POLIPROPILENE:**
bianco - grigio chiaro
ottanio eliminato

OPTIONAL



Art. 998 RPQ
set parquet
COD. 0018



Art. 998 PDF
set fisso
COD. 0016

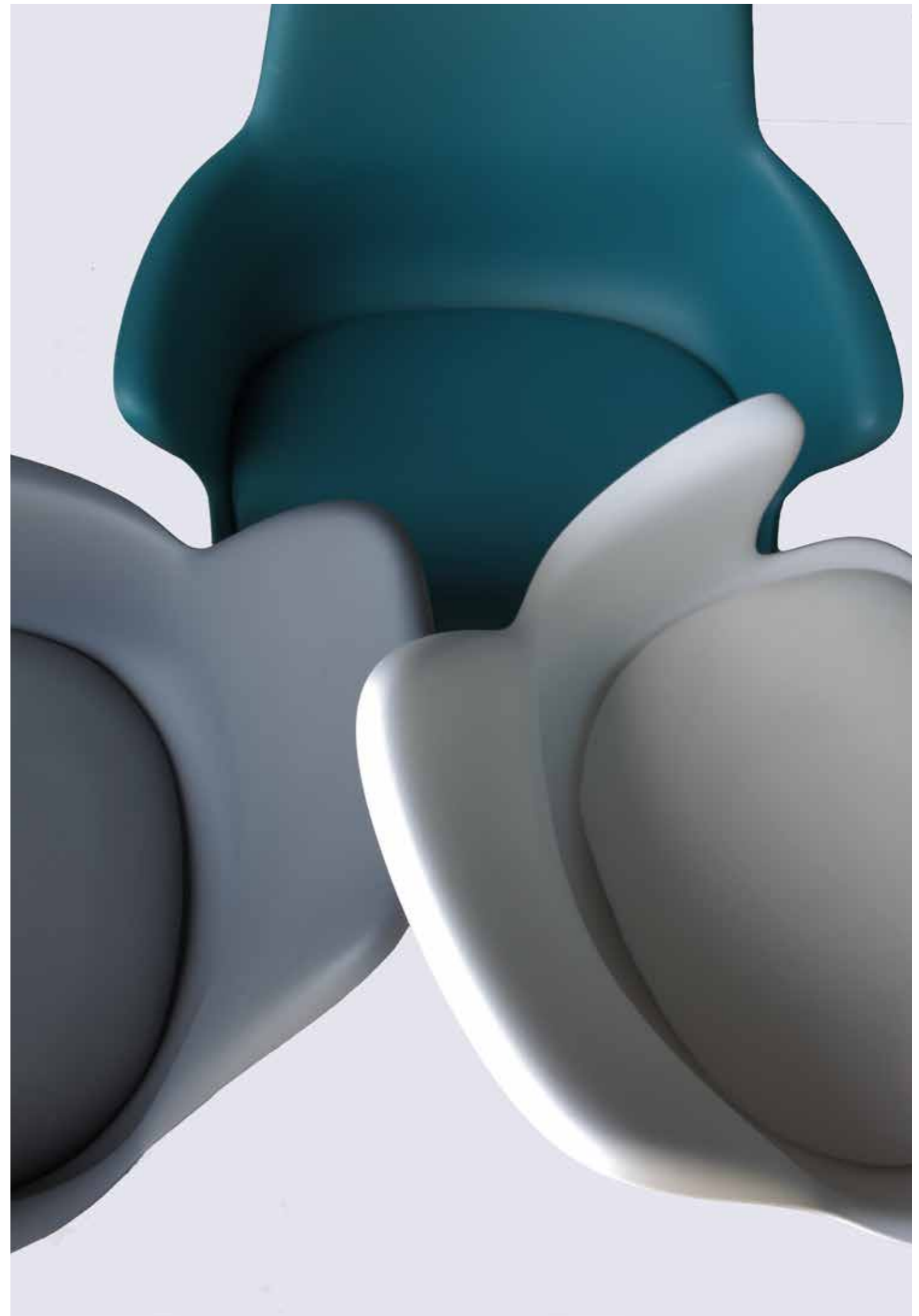



Art. 931 Pixel

- IMBALLO N. 1 pz.
- **NORMALMENTE IN PRONTA CONSEGNA**
- SEDILE GIREVOLE CON ALZO A GAS
- MECCANISMO BASCULANTE
- STRUTTURA
- SCHIENALE: TECNORETE MICROFORATA
- SEDILI: PUMA NERO

CROMATO

COD. 00228

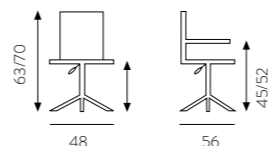

OPTIONAL



Art. 998 RPQ
set parquet
COD. 0018

Art. 998 PDF
set fisso
COD. 0016



Art. 932 Speed

- IMBALLO N. 1 pz.
- **NORMALMENTE IN PRONTA CONSEGNA**
- SEDILE GIREVOLE CON ALZO A GAS
- MECCANISMO BASCULANTE
- STRUTTURA
- SEDILI: PUMA NERO con particolari ecopelle

CROMATO

COD. 00238

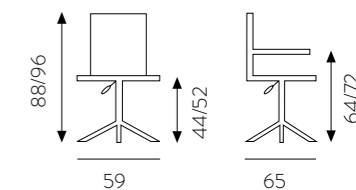



traslabile

pulsantino



bracciolo
regolabile e traslabile

OPTIONAL



Art. 998 RPQ
set parquet
COD. 0018



Art. 998 PDF
set fisso
COD. 0016

Art. 937 Urus

- IMBALLO N. 1 pz.
- **NORMALMENTE IN PRONTA CONSEGNA**
- SEDILE GIREVOLE CON ALZO A GAS - BASE DESIGN
- SEDUTA FISSA - BRACCIOLI REGOLABILI E TRASLANTI
- TESSUTO TECNICO / RETE **NERA**

COD. 00228

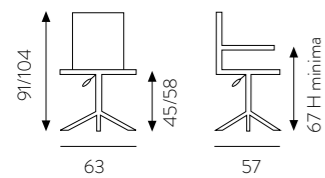

Art. 302 Delta

- IMBALLO N. 2 pz.
Imballo speciale 1 pz. + 10,00 netto
- **NORMALMENTE IN PRONTA CONSEGNA**
- STRUTTURA: CROMATO
- SEDILI
CUOIO RIGENERATO: **nero** COD. 00186

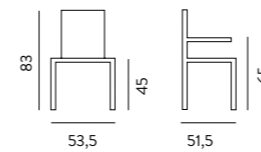
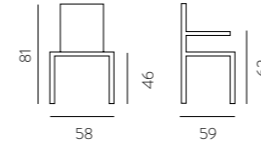

Art. 981 Kubica

- IMBALLO N. 2 pz.
Imballo speciale 1 pz. + 10,00 netto
- **NORMALMENTE IN PRONTA CONSEGNA**
- STRUTTURA: CROMATO
- ECOPELLE: **bianca - nera** COD. 00346





Art. 988 Silla

- IMBALLO N. 2 pz.
Imballo speciale 1 pz. + 10,00 netto
- **NORMALMENTE IN PRONTA CONSEGNA**
- STRUTTURA TUBOLARE NERO
- STOFFA nera COD. 00240



poggiareni regolabile

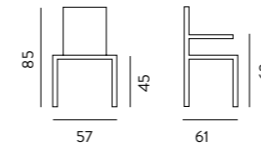

Art. 938 Jet

- IMBALLO N. 1 pz.
- **NORMALMENTE IN PRONTA CONSEGNA**
- SEDILE GIREVOLE CON ALZO A GAS - BASE DESIGN
- **REGOLAZIONE SYNCRON** (sedile/schienale bloccabile 4 posizioni) con antishok per evitare, dopo lo sblocco, l'impatto brusco sulla schiena
- TESSUTO TECNICO / RETE NERO COD. 00340

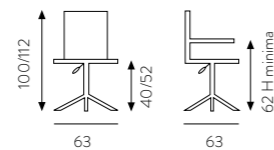

OPTIONAL



Art. 998 RPQ
set parquet
COD. 0018



Art. 998 PDF
set fisso
COD. 0016



pulsantino

bracciolo regolabile





poggiatesta regolabile

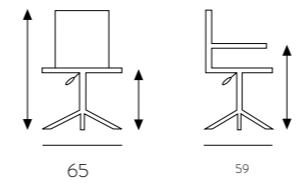

meccanismo sincron
regola inclinazione
sedile/schienale



alzo a gas

Art. 927 Gravity

- IMBALLO N. 1 pz.
- **NORMALMENTE IN PRONTA CONSEGNA**

- SEDILE GIREVOLE CON ALZO A GAS
- MECCANISMO SINCRON

- STRUTTURA
- SCHIENALE: TECNORETE MICROFORATA
- SEDILI: PUMA NERO

COD. 00340



Art. 929/... Futura

- IMBALLO N. 1 pz.
- **NORMALMENTE IN PRONTA CONSEGNA**
- SEDILE GIREVOLE CON ALZO A GAS
- MECCANISMO SINCRON (regola inclinazione sedile/schienale)
- BRACCIOLI REGOLABILI IN ALTEZZA
- POGGIARENI
- RUOTE GOMMATE DI SERIE
- PARTICOLARI COLOR ALLUMINIO
- STRUTTURA: NYLON NERO
- SCHIENALE: TECNORETE MICROFORATA
- SEDILI: PUMA NERO

929/A ALTA

COD. 00396

929/B BASSA (SENZA POGGIATESTA)

COD. 00376

braccioli
regolabili

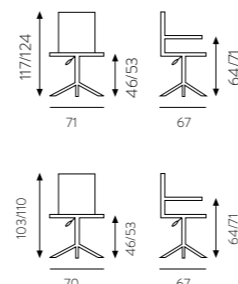

Art. 925/... Genesis

- IMBALLO N. 1 pz.
- **NORMALMENTE IN PRONTA CONSEGNA
DISPONIBILI DA SETTEMBRE 2024**
- SEDILE GIREVOLE CON ALZO A GAS
- MECCANISMO SINCRON (regola inclinazione sedile/schienale)
- BRACCIOLI REGOLABILI IN ALTEZZA E ORIZZONTALMENTE
- POGGIARENI REGOLABILE
- STRUTTURA: NYLON NERO
- SCHIENALE: TECNORETE MICROFORATA
- SEDILI: PUMA NERO

925/A ALTA

COD. 00396

925/B BASSA (SENZA POGGIATESTA)

COD. 00376





Mod. Sistema

- SEDILE GIREVOLE CON ALZO A GAS
- MECCANISMO BASCULANTE
- STRUTTURA CROMATA
- SEDILI / SCHIENALE ECOPELLE: bianco - nero - grigio titanio

NORMALMENTE IN PRONTA CONSEGNA

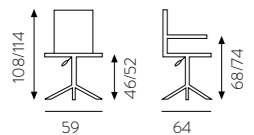

Art. 928/A Sistema alta

COD. 00580

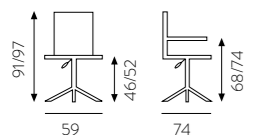

Art. 928/B Sistema bassa

COD. 00550

OPTIONAL



Art. 998 RPQ
set parquet
COD. 0018



Art. 998 PDF
set fisso
COD. 0016

NERO



GRIGIO TITANIO



BIANCO



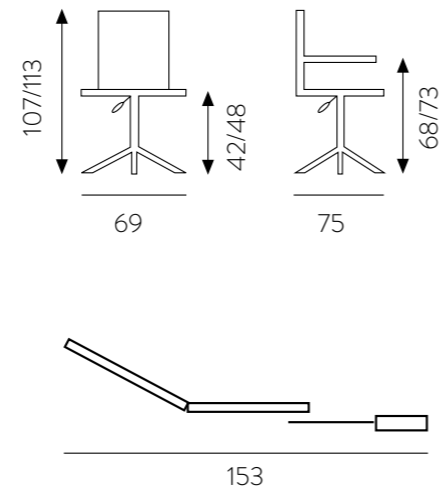

Art. 926 Galaxy

- IMBALLO N. 1 pz.
- **NORMALMENTE IN PRONTA CONSEGNA**
- SEDILE GIREVOLE CON ALZO A GAS
- MECCANISMO RECLINABILE
- BASE CROMATA
- SCHIENALE: ECOPELLE
- SEDILI: ECOPELLE nera COD. 00490
- SET RUOTE PARQUET + € 16,00



Art. 923 Revolving

- IMBALLO N. 1 pz.
- **NORMALMENTE IN PRONTA CONSEGNA**
- SEDILE GIREVOLE CON ALZO A GAS
- MECCANISMO BASCULANTE
- BASE: IN FUSIONE CROMATA
- SCHIENALE: ECOPELLE
- SEDILI: PELLE nera

COD. 00560

OPTIONAL



Art. 998 RPQ
set parquet
COD. 0018



Art. 998 PDF
set fisso
COD. 0016

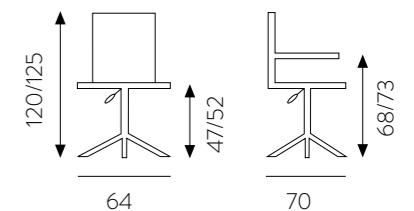



Tutti i diritti sono riservati pertanto è severamente vietata la riproduzione delle immagini, dei disegni e quant'altro appare su questo catalogo. Il presente catalogo ha carattere puramente illustrativo. L'azienda declina ogni responsabilità per eventuali non conformità di colori delle finiture dei materiali utilizzati. Caratteristiche e dimensioni di tutti i prodotti sono soggetti a variazioni senza preavviso e non sono impegnative per la l'azienda. L'azienda non potrà essere ritenuta responsabile per eventuali errori di stampa contenuti in questo catalogo.